



OPERATION MANUAL

Milliohmmeter RESISTOMAT® Model 2316

© 2024 burster
praezisionsmesstechnik gmbh & co kg
All rights reserved

Software version V 201801

Valid from: 04.03.2024

Manufacturer:

burster praezisionsmesstechnik gmbh & co kg
Talstr. 1 - 5 P.O.Box 1432
76593 Gernsbach 76587 Gernsbach
Germany Germany

Tel.: +49-7224-645-0
Fax.: +49-7224-645-88
Email: info@burster.com
www.burster.com

4520-BA2316EN-5699-031527

Exclusion of warranty liability for operating manuals

All information in the present documentation was prepared and compiled with great care and reproduced subject to effective control measures. No warranty is provided for freedom from errors. We reserve the right to make technical changes. The present information as well as the corresponding technical data can change without notice. Reproduction of any part of this documentation or its processing or revision using electronic systems is prohibited without the manufacturer's prior written approval.

Components, devices and measured value sensors made by burster praezisionsmesstechnik (hereinafter referred to as „product“) are the results of targeted development and meticulous research. As of the date of delivery, burster provides a warranty for the proper condition and functioning of these products covering material and production defects for the period specified in the warranty document accompanying the product. However, burster excludes guarantee or warranty obligations as well as any liability beyond that for consequential damages caused by improper use of the product, in particular the implied warranty of success in the market as well as the suitability of the product for a particular purpose. Furthermore, burster assumes no liability for direct, indirect or incidental damages as well as consequential or other damages arising from the provision and use of the present documentation.

The measurement solution.

burster

EU-Konformitätserklärung (nach EN ISO/IEC 17050-1:2010)*EU-Declaration of conformity (in accordance with EN ISO/IEC 17050-1:2010)*

Name des Ausstellers: burster präzisionsmesstechnik gmbh & co kg
Issuer's name:

Anschrift des Ausstellers: Talstr. 1-5
Issuer's address: 76593 Gernsbach, Germany

Gegenstand der Erklärung: Milliohmometer RESISTOMAT® für Fertigung und Labor
Object of the declaration: Milliohmometer RESISTOMAT® for Production and Laboratory

Modellnummer(n) (Typ): 2316
Model number / type:

Diese Erklärung beinhaltet obengenannte Produkte mit allen Optionen
This declaration covers all options of the above product(s)

Das oben beschriebene Produkt ist konform mit den Anforderungen der folgenden Dokumente:
The object of the declaration described above is in conformity with the requirements of the following documents:

Dokument-Nr. <i>Documents No.</i>	Titel <i>Title</i>	Ausgabe <i>Edition</i>
2011/65/EU + delegD (EU) 2015/863	Richtlinie zur Beschränkung der Verwendung bestimmter gefährlicher Stoffe in Elektro- und Elektronikgeräten <i>Directive on the restriction of the use of certain hazardous substances in electrical and electronic equipment</i>	2011 + 2015
2014/35/EU	Richtlinie zur Harmonisierung der Rechtsvorschriften der Mitgliedsstaaten über die Bereitstellung elektrischer Betriebsmittel zur Verwendung innerhalb bestimmter Spannungsgrenzen auf dem Markt <i>Directive on the harmonization of the laws of the Member States relating to the making available on the market of electrical equipment designed for use within certain voltage limits</i>	2014
2014/30/EU	Richtlinie zur Harmonisierung der Rechtsvorschriften der Mitgliedsstaaten über die Elektromagnetische Verträglichkeit <i>Directive on the harmonization of the laws of the Member States relating to electromagnetic compatibility</i>	2014
EN 61010-1	Sicherheitsbestimmungen für elektrische Mess-, Steuer-, Regel- und Laborgeräte – Teil 1: Allgemeine Anforderungen <i>Safety requirements for electrical equipment for measurement, control and laboratory use – Part 1: General requirements</i>	2010 + Cor.:2011
EN 61326-1	Elektrische Mess-, Steuer-, Regel- und Laborgeräte – EMV-Anforderungen – Teil 1: Allgemeine Anforderungen <i>Electrical equipment for measurement, control and laboratory use – EMC requirements – Part 1: General requirements</i>	2013
EN 55011	Industrielle, wissenschaftliche und medizinische Geräte – Funkstörungen – Grenzwerte und Messverfahren <i>Industrial, scientific and medical equipment – Radio-frequency disturbance characteristics – Limits and methods of measurement</i>	2018

Gernsbach 26.05.2020 ppa. Christian Karius
Ort / place Datum / date Quality Manager

Dieses Dokument ist entsprechend EN ISO/IEC 17050-1:2010 Abs. 6.1g ohne Unterschrift gültig
According EN ISO/IEC 17050 this document is valid without a signature.

burster präzisionsmesstechnik gmbh & co kg

Talstr. 1-5 · DE-76593 Gernsbach
 Tel. (+49) 07224-6450
 info@burster.com

Geschäftsführer/Managing Director: Matthias Burster
 Handelsregister/Trade Register: Gernsbach
 Registergericht/Register Court: Mannheim HRA 530170

Kompl./Gen. Partn.: burster präzisionsmesstechnik Verwaltungs-GmbH
 Handelsregister/Trade Register: Gernsbach
 Registergericht/Register Court: Mannheim HRB 530130

burster is ISO 9001:2015 certified

www.burster.com

Table of contents

1	Safety instructions	9
1.1	Symbols in this manual	9
1.2	Signal words.....	9
1.3	Pictograms	9
2	Introduction	10
2.1	Use.....	10
2.2	Description	10
3	Preparations for use	11
3.1	Unpacking the unit	11
3.2	Using the instrument for the first time	11
3.3	Supply voltage, power switch and mains fuse	11
3.4	Power supply and signal-lead connectors.....	12
3.5	Block diagram	13
3.6	Setup and installation.....	14
3.7	Functional test.....	14
3.8	Calibration	14
3.9	Storage.....	14
3.10	Safety instructions.....	15
4	Controls	16
4.1	Front panel	16
4.1.1	Button functions.....	16
4.2	Rear panel.....	17
4.2.1	Description of connector sockets.....	17
5	Operating instructions in brief	19
6	Operation	21
6.1	Meaning of the individual display segments.....	21
6.2	Start-up menuThe first menu is displayed after power up:	22
6.3	Configuration menu.....	23
6.4	Measurement menu	24
6.4.1	Measurement mode.....	24
6.5	Description of the individual setup menus.....	25
6.5.1	Measuring range.....	25
6.5.2	Limits	26
6.5.3	Load selection.....	27
6.5.3.1	Handling inductive loads e.g. reactors, cables on reels, motors, coils, transformers.....	28
6.5.4	Measurement mode.....	30

6.5.4.1	Continuous operation	30
6.5.4.2	Single shot.....	31
6.5.4.3	Alternating measurement mode	32
6.5.4.4	FAST MEASURE.....	32
6.5.4.5	Cooling curve	33
6.5.5	Temperature compensation	36
6.5.6	Autozero / Man-Zero.....	37
6.5.7	Device program	38
6.5.8	Comparator.....	39
6.5.9	Contrast.....	40
6.5.10	Temperature sensor.....	41
6.5.11	Display counts	43
6.5.12	Self test.....	44
6.5.13	Access to password.....	47
6.5.14	Interfaces	48
6.5.14.1	RS232 Interface	48
6.5.14.2	USB Interface.....	50
6.5.14.3	Ethernet Interface.....	50
6.5.14.4	Printer interface	51
6.5.15	Reference temperature.....	52
6.5.16	Reference length	53
6.5.17	Measurement current selection	54
6.5.18	Calibration.....	54
7	Controlling the instrument remotely.....	55
7.1	Controlling the instrument via the PLC interface.....	55
7.2	Controlling the instrument via the RS232 interface.....	56
7.2.1	Connector pin-out for the RS232 interface	56
7.2.2	Interface parameters.....	57
7.2.2.1	RS232	57
7.2.2.2	USB.....	57
7.2.2.3	Ethernet.....	57
7.2.2.4	Printer.....	57
7.2.3	Communications protocol	57
7.2.4	Establishing a connection	58
7.2.5	Selection with response.....	59
7.2.6	Fast selection.....	59
7.2.7	Polling	60
7.2.8	Data transfer.....	60
7.2.9	Terminating a connection.....	60

7.2.10	Examples of the communication sequence	61
7.2.10.1	Communication using „selection with response“	61
7.2.10.2	Communication using „fast selection“	61
7.3	Controlling the instrument via Ethernet interface	62
7.3.1	The TCP transmission protocol	62
7.3.2	Programming example for “fast selection”	62
7.3.3	Programming example for „selection with response“	63
7.4	General information.....	64
7.4.1	Interface watchdog timer	64
7.4.1.1	Timer A (response timer)	64
7.4.1.2	Timer B (receive timer).....	64
8	SCPI commands	65
8.1	General information.....	65
8.1.1	Compatibility with 2318-V001	65
8.1.2	Functions that have changed.....	66
8.1.3	List of old commands.....	67
8.2	SCPI registers	68
8.3	ACCess Subsystem	69
8.3.1	ACCess:LEVel	69
8.4	DISPlay Subsystem	70
8.4.1	DISPlay:CONTrast.....	70
8.5	CALCulate Subsystem	71
8.5.1	CALCulate:LIMit:STATe	71
8.5.2	CALCulate:LIMit:RELais	72
8.5.3	CALCulate:LIMit:RESet	73
8.5.4	CALCulate:LIMit:LOWer	74
8.5.5	CALCulate:LIMit:UPPer	75
8.5.6	CALCulate:LIMit:ACKNowledge?	76
8.5.7	CALCulate:LIMit:CONTRol:DATA.....	76
8.5.8	CALCulate:MATH[:EXPRession]	77
8.6	SCALE Subsystem.....	78
8.6.1	SCALE:VOLTage	78
8.6.2	SCALE:PT100	79
8.7	HCOPy Subsystem	80
8.7.1	HCOPy:DESTination.....	80
8.8	CCURve Subsystem	81
8.8.1	CCURve:TIME:END	81
8.8.2	CCURve:TIME:DELTA	82
8.8.3	CCURve:COUNt.....	82
8.8.4	CCURve:DATA.....	83

8.8.5	CCURve:CHARge	83
8.8.6	CCURve:INITiate	84
8.8.7	CCURve:ABORt	84
8.9	TRACe Subsystem.....	85
8.9.1	TRACe:DATA:LENGth	85
8.10	TRIGger Subsystem.....	85
8.10.1	ABORt.....	85
8.10.2	INITiate[IMMediate].....	86
8.10.3	INITiate:CONTInuous.....	86
8.10.4	FETCh?	87
8.11	SYSTem subsystem	87
8.11.1	SYSTem:VERSion?	87
8.11.2	SYSTem:LANGUage	88
8.11.3	SYSTem:PASSword.....	88
8.11.4	SYSTem:ERRor[:NEXT]?	89
8.12	STATus Subsystem	90
8.12.1	STATus:PRESet.....	90
8.12.2	STATus:OPERation:ENABle	90
8.12.3	STATus:QUEStionable:ENABle	91
8.12.4	STATus:OPERation:CONDition?	91
8.12.5	STATus:QUEStionable:CONDition?	92
8.12.6	STATus:OPERation[:EVENT]?.....	92
8.12.7	STATus:QUEStionable:[EVENT]?	93
8.13	SENSe Subsystem.....	94
8.13.1	SENSe:TCOMpensate.....	94
8.13.2	SENSe:TCOMpensate:STATe	95
8.13.3	SENSe:TCOMpensate:TEMPerature	96
8.13.4	SENSe:TCOMpensate:TEMPerature:REFerence	97
8.13.5	SENSe:TCOMpensate:TCOefficient:SELEct	98
8.13.6	SENSe:TCOMpensate:TCOefficient:USER:CHANge	99
8.13.7	SENSe:FRESistance:RESolution	100
8.13.8	SENSe:FRESistance:MODE	101
8.13.9	SENSe:FRESistance:TIME:CONStant	102
8.13.10	SENSe:FRESistance:RANGe?.....	103
8.13.11	SENSe:FRESistance:RANGe:AUTO.....	104
8.13.12	SENSe:FRESistance:RANGe:UPPer	105
8.13.13	SENSe:FRESistance:RANGe:LOWer	106
8.13.14	SENSe:FRESistance:RANGe:MANual.....	107
8.13.15	SENSe:AVERAge:COUNt.....	108
8.13.16	SENSe:CORRection:OFFSet	108

8.13.17	SENSe:CORRection:OFFSet:AUTO:STATe	109
8.14	SOURce Subsystem	110
8.14.1	SOURce:CURRent[:LEVel:IMMEdiate:AMPLitude]	110
8.15	IEEE-488.2 commands	110
8.15.1	*SRE command	110
8.15.2	*STB? Command.....	111
8.15.3	*ESE command	111
8.15.4	*ESR? Command	111
8.15.5	*OPC command.....	112
8.15.6	*RST command	112
8.15.7	*TST? Command.....	112
8.15.8	*WAI command.....	112
8.15.9	*CLS command.....	113
8.15.10	*IDN? Command	113
8.15.11	*RCL command	113
8.16	Programming examples	114
8.16.1	Communication using „selection with response“	114
8.16.2	Communication using „fast selection“	116
8.16.3	Programming Example	118
9	Maintenance, Customer service, Shipping, Cleaning	119
9.1	Maintenance.....	119
9.2	Customer service	119
10	Appendix	120
10.1	Technical data	120
10.2	Calibration and Adjustment	122
10.3	Error messages and troubleshooting	122
11	Disposal.....	124



1 Safety instructions

On the device RESISTOMAT® 2316 and in this manual the following symbols warn about risks:

1.1 Symbols in this manual

1.2 Signal words



The following signal words are used in the operating manual according to the specified hazard classification.

	DANGER
DANGER indicates a hazard with a high level of risk which, if not avoided, will result in death or serious injury.	
	WARNING
WARNING indicates a hazard with a medium level of risk which, if not avoided, could result in death or serious injury.	
	CAUTION
CAUTION indicates a hazard with a low level or risk which, if not avoided, could result in minor or moderate injury.	
NOTICE	
Property damage to the equipment or the surroundings will result if the hazard is not avoided.	

Note: It is important to heed these safety notices in order to ensure correct handling of the RESISTOMAT® 2316.

IMPORTANT: Follow the information given in the operating manual.

1.3 Pictograms

	Danger of electric shock!
	Observe the safety notices for protecting the instrument.
	Observe the operation manual for further information and details!

2 Introduction

IMPORTANT: Read the operation manual carefully before using the equipment, and keep for future reference.

2.1 Use

Fast and accurate measurements of ultra-small resistances can be made using the RESISTOMAT® type 2316 milliohmmeter. With its rugged table-top case and membrane keypad, this instrument is designed for both laboratory use and harsh industrial environments.

Temperature-compensated resistance-testing of wires and coils is possible using a Pt 100 sensor or pyrometer to measure the temperature of the device under test. The instrument then corrects the resistance to e.g. 20 °C (selectable).

The meter has a huge range of applications such as measuring:

- transformer/motor windings
- coils of any kind
- cables and wires on the drum or as meter samples
- switch and relay contacts
- heating elements
- fuses
- connections and contacts to power rails and much more.

For a cooling curve recording with freely selectable time interval a data logger for up to 1000 values is available.

Complete control capability via the PC interfaces means that fully automatic test stations can be set up. The meter includes a PLC interface for integration in production process controllers. A 2-way comparator with PLC and relay switching outputs is also provided for classification and selection of the devices under test.

2.2 Description

The meter works on the basis of the proven four-wire measurement method in which test-lead resistances and contact resistances are eliminated. The measurement technique also compensates automatically for any thermal EMFs in the measurement circuit. The instrument leads are monitored for damage by a built-in detector.

Of course the meter includes temperature compensation for any type of material under test such as copper, aluminum, brass, tungsten etc. using an external Pt 100 sensor or external infrared thermometer (accessory) to measure the temperature. A special circuit for protecting the measurement input when measuring high-inductance devices has been developed to prevent damage to the meter from voltage peaks produced when disconnecting the device under test.

If there is a requirement to test devices using different parameters in an automatic test setup, then up to 16 device settings such as measuring range, limits, temperature coefficient etc. can be saved. All device-specific settings are shown on the display.

The settings can be retrieved via the keypad or PLC interface using a bit pattern (4 bits). Of course all device settings can also be made via the various interfaces.

A backlit, high-contrast LCD display is used for displaying the readings, so it is extremely easy to read the measurement in both dark and well-lit rooms.

3 Preparations for use

3.1 Unpacking the unit

The instrument weighs 3.5 kg and is packaged accordingly to protect against shock.

Unpack the instrument carefully and verify that all items are present.

This normally includes: 1 RESISTOMAT® model 2316 milliohmmmeter

1 power lead

1 copy of this manual

Inspect the instrument carefully for damage.

If you suspect that the instrument has been damaged during shipping, notify the delivery company immediately.



The packaging should be retained for examination by a representative of the manufacturer and/or the delivery company.

The RESISTOMAT® model 2316 should be shipped only in its original packaging or in packaging capable of providing an equivalent degree of protection.

3.2 Using the instrument for the first time

If condensation has formed on the instrument, make sure that the instrument is completely dry (including inside) before switching it on.

Connect the instrument to a standard grounding outlet using the power lead supplied.

	 DANGER
	Danger of electric shock! The instrument must never be switched on if it shows signs of damage during shipping. The case or measurement input can carry life-threatening voltages if the mains voltage is transferred as a result of damage.

3.3 Supply voltage, power switch and mains fuse

The instrument can be operated with supply voltages of 85 to 264 V AC without presetting the mains voltage.

The power consumption is about 30 VA.

The fuse rating for a supply voltage of 230 V or 115 V is 3.15 AT. The mains fuse is located between the mains socket and power switch on the rear of the unit.

Make sure that the unit is fully disconnected from the electrical mains before changing the fuse. This should be done by removing the power lead from the mains socket; always pull on the connector itself, never the cable.

Only use original fuses 5 x 20 mm 3.15 AT.

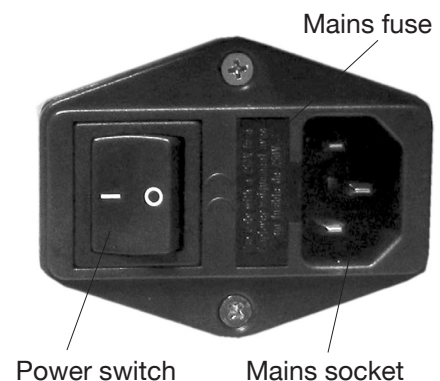

3.4 Power supply and signal-lead connectors

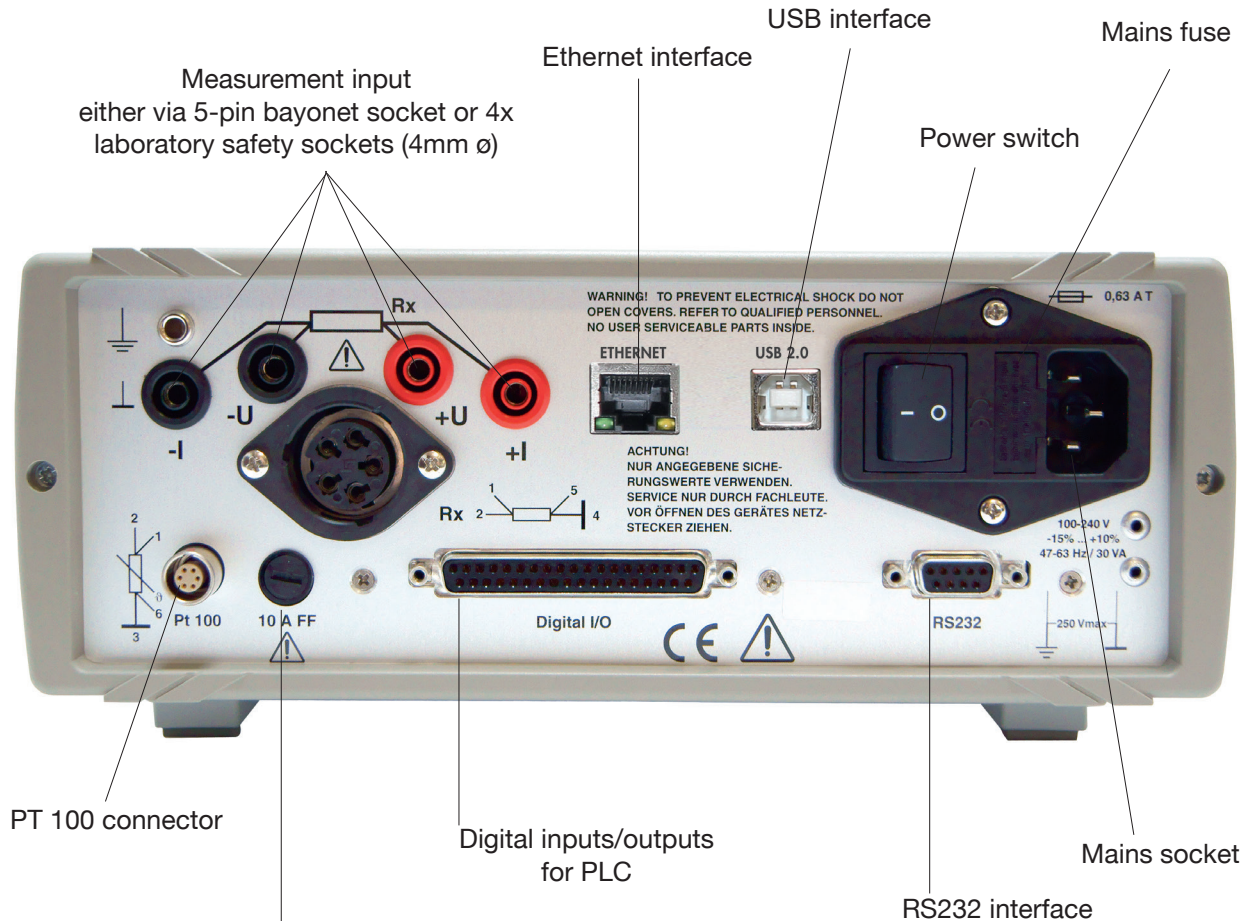

IMPORTANT: additional protection of the measurement current using a super quick-acting 10 A fuse 6.3 x 32 mm, 600 V_{AC}, 50 kA breaking capacity (or greater) RS Components #209-9406 (in Germany) **Only use this fuse**

NOTICE

- Use a suitable connecting cable with a dual-shield construction (aluminum foil cladding plus braided shield) for the communications port connection and the PLC I/O signal control lines.
- Observe the minimum line length required.
- Use metallic or metal-plated connecting plugs. Connect the braided shield of shielded cables to the connector casing.
- When using detachable extension leads, make sure the shielding is continuous.
- Always use a Pt100 sensor with shielded cable to connect to the Pt100 connector. The cable shield must not be in contact with the connector shell if grounding of the sensor is unclear. Otherwise currents circulating in a ground loop can cause measuring errors.
- **Only one device under test must be connected across the two parallel measurement inputs. No leads must be plugged into the unused connector for safety reasons.**

3.5 Block diagram

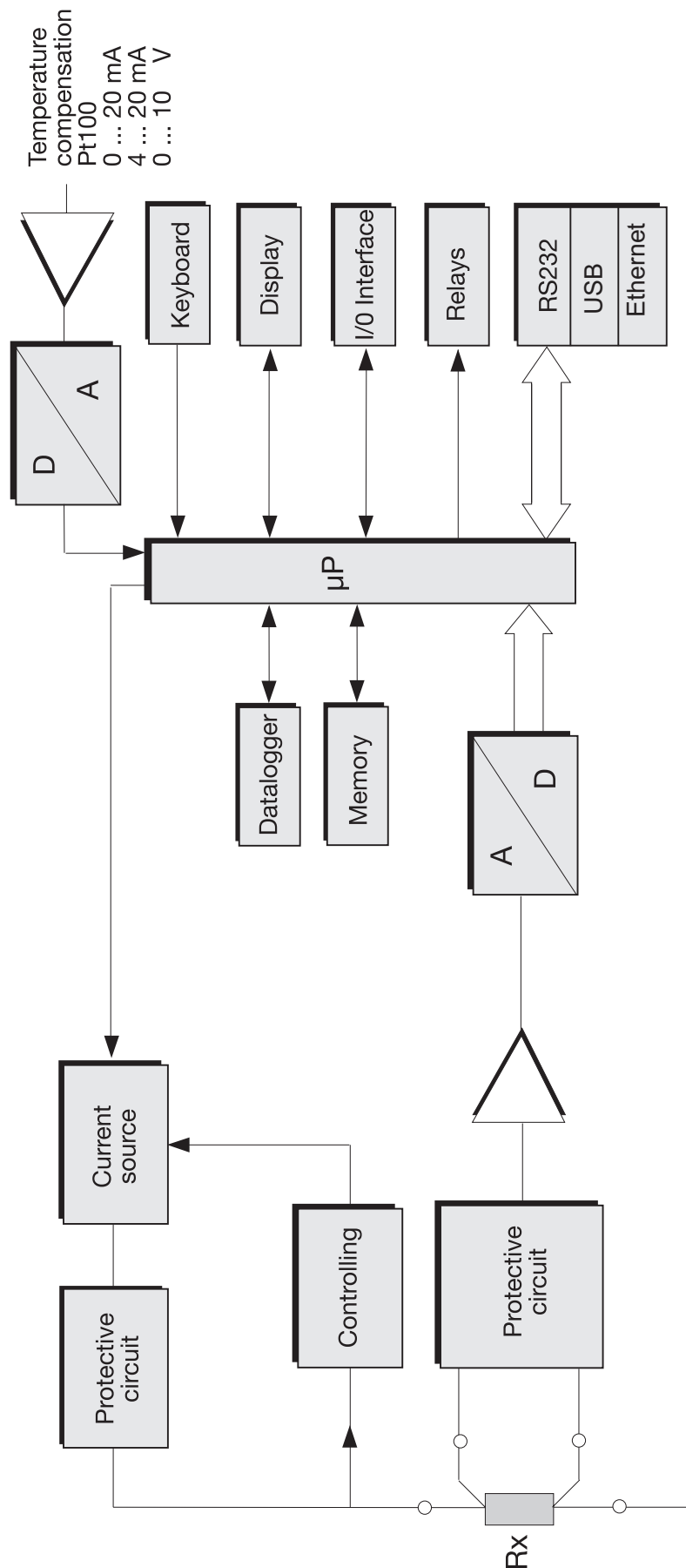

3.6 Setup and installation

- Ensure that there is an adequate supply of air to prevent heat building up in the instrument.
- Do not place the instrument on surfaces such as carpets or cloths, or near materials such as curtains or wall hangings that could prevent the air circulating.
- Do not place the instrument at an inclined angle. It should always be used in a horizontal position.
- Keep the instrument away from apparatus, equipment, machines and installations that generate strong magnetic fields.
- Do not place heavy objects on the instrument.
- Condensation can form inside the instrument if it is taken directly from a warm room into a cold room. Wait a few hours before switching on the instrument.
- Make sure that the display panel is not mechanically stressed.
- The instrument must have reached thermal equilibrium.
- Select the installation location so that the instrument is not exposed to extreme temperatures (operating temperature range 0 to 50° C) or temperature variations, nor to humidity, direct sunlight, incandescent lamps, dust, oils, organic solvents, other aerosols or severe vibrations or mechanical shocks. In very dirty industrial environments, it is recommended to use a suitable protective enclosure.

3.7 Functional test

After switching on the instrument, the following text appears on the display for about 3 s:

	RESISTOMAT 2316 VERSION: SERIAL NUMBER SOFTWARE VERSION CAL NUMBER		
	LANGUAGE	TEST	

Then the instrument switches directly to the measurement menu.

3.8 Calibration

The meter was calibrated before shipping. The calibration history of the instruments used for the calibration can be traced to the government measurement standard in accordance with DIN ISO 17025. The meter should be recalibrated after a period of about one year. Calibration is performed using the RS232 interface, and should only be performed at the manufacturer's premises. The customer can perform the calibration in-house by purchasing the PC software 2316-P001.

3.9 Storage

For long-term storage, pack the unit, along with a desiccant, into an airtight, sealed polyethylene bag. Do not store the unit where it will be exposed to sunlight or other light sources. Take care to ensure that nothing comes in contact with the display panel. The storage temperature range is 0 to 70°C. However, to maximize the lifespan of the display, the temperature should not exceed 50°C.

3.10 Safety instructions



DANGER

Whilst the hardware and software has been developed and tested in accordance with the state of the art, they cannot be guaranteed totally free of errors. Thus this instrument or part of this instrument must not be used to influence a control system from which risk to life or property can arise directly or indirectly without additional protection. Maintenance and repair work must only be performed by trained, competent technical personnel familiar with the associated risks.

- The instrument has two measurement inputs connected in parallel; only one of these inputs must be used at any one time. No leads must be plugged into the unused connector for safety reasons. The unused circular socket must be covered with the cap supplied.
- Before starting any measurement, make sure that the device under test does not carry an external voltage (e.g. mains voltage, voltage generated by a rotating motor etc.).
- Take care when handling inductive devices under test. By the physical nature of these devices, life-threatening induction voltages can be generated when the test current is disconnected. Read the instructions in the “Load selection” section. (See section 6.5.3)
- To avoid electric shock, never open the case. The instrument contains no components that can be maintained, adjusted or calibrated by the customer. The instrument can operate with all standard mains voltages in the world without needing to be switched over.
- Always replace fuses with fuses of the same type. Never use fuses with different characteristics or other rated currents. Before changing the fuse, pull out the mains plug and short-circuit the device under test.
- Should foreign bodies or liquids get inside the unit, disconnect the main lead. Get the instrument checked over by qualified technical personnel before using it again.
- Always leave repair work to qualified technical personnel.
- If you do not intend using the instrument for a prolonged period, take the mains plug out of the socket. Always pull on the connector itself, never the cable.
- Should liquid from a broken display escape from the unit and get on your hands, wash your hands thoroughly using soap and water. Remove any residues of the liquid with acetone or ethanol.
- Always keep the instrument out of rain or away from moisture to prevent a fire hazard or the risk of electric shock.
- Check the mains lead before use.

4 Controls

4.1 Front panel

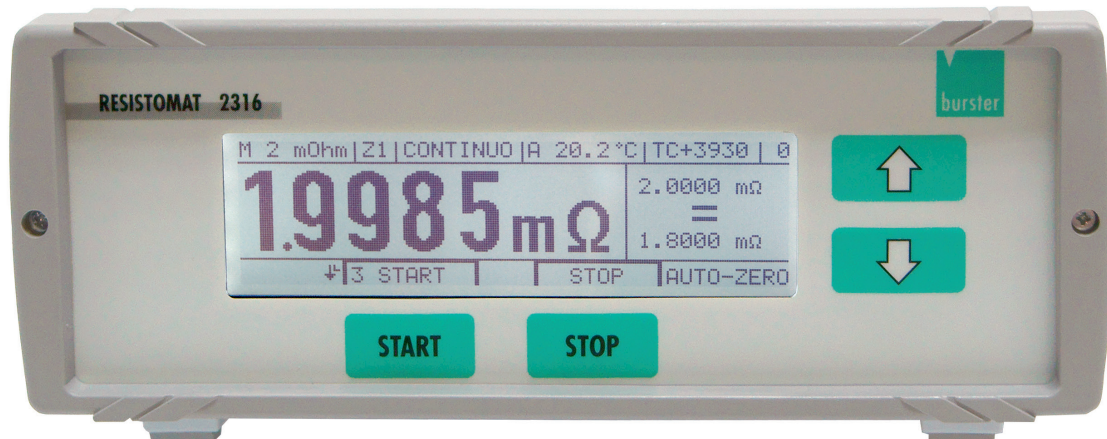

Front panel with backlit LCD display and integral membrane keypad with tactile feedback

4.1.1 Button functions

[START] : In the measurement menu this button starts a measurement

In the Configuration menu this button is assigned different functions depending on the text shown on the display above the button (soft key).

[STOP] : In the measurement menu this button stops a measurement.

In the Configuration menu this button is assigned different functions depending on the text shown on the display above the button (soft key).

[↑] : In the measurement menu and for manual range-selection can be used to increase the measuring range.

In the Configuration menu the button has a cursor (up) function.

[↓] : In the measurement menu and for manual range-selection can be used to decrease the measuring range.

In the Configuration menu the button has a cursor (down) function.

[↑↓] : Pressing both buttons simultaneously

[↑↓] : Opens the Configuration menu.

RESISTOMAT® Model 2316

4.2 Rear panel

4.2.1 Description of connector sockets

Measurement input

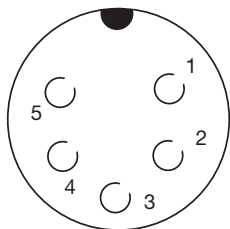

View towards socket

- | | |
|---|------------|
| 1 | + U |
| 2 | + I |
| 3 | Analog GND |
| 4 | - I |
| 5 | - U |

Connector shell : PE (protective ground) potential
Mating connector: burster model 9900-V172

Note: The current branch is protected by a fuse 6.3 x 32 [mm] 10AFF. (rear side of unit)

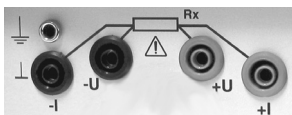

- I is at FE potential

	CAUTION
<p>Only one measurement input must be used at any one time. No leads must be plugged into the unused input for safety reasons.</p>	

Pt100 input

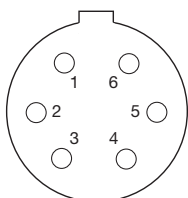

View towards socket

- | | |
|---|-------------------|
| 1 | + U |
| 2 | + I |
| 3 | - I |
| 4 | Functional ground |
| 5 | Functional ground |
| 6 | - U |

Connector shell : PE (protective ground) potential

Mating connector : burster model 4291-0

Two-wire technology is possible if the relevant conductors are joined together at the sensor.

Note: NEVER connect the cable shield to the connector shell if the grounding at the sensor end is unclear. Otherwise, if there is a ground connection at the temperature sensor, measuring errors may result from circulating ground-loop currents. (Connector shell is protective ground)

RS232 interface

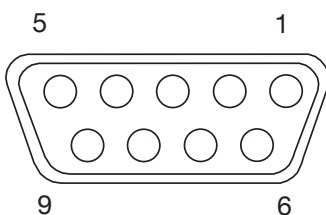

9-pin min sub-D female connector
View towards socket

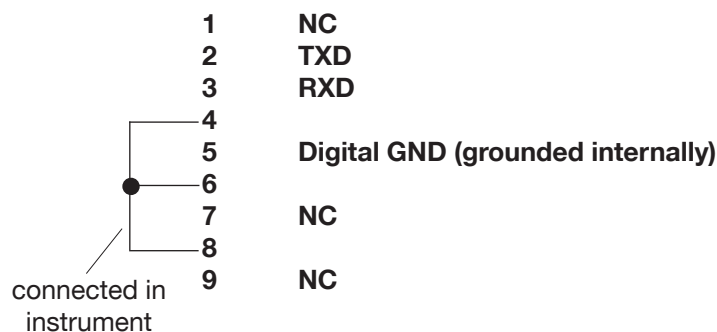

Connector shell : PE potential
Mating connector: Model 9900-V209
Matching data cable: Model 9900-K333

USB interface

USB 2.0



Use a USB A male to USB B male cable (burster part number 9900-K349, length 2m) to connect to a PC USB port.

Ethernet interface

ETHERNET



Use a standard patch cable of category "Cat5e" or above for connecting to an Ethernet network.

Digital I/O

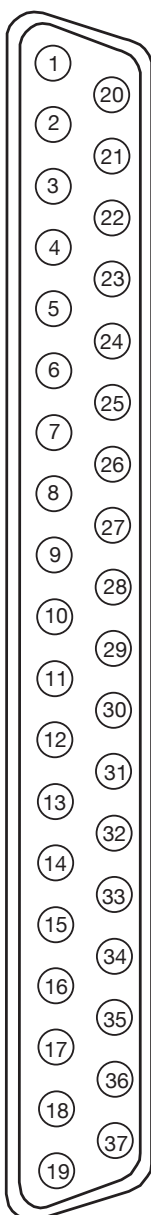

Pin	Function	Function
1	Relay	<, NO contact
2	Not used	
3	Relay	=, NO contact
4	PLC output	Device program saved ok
5	Relay	>, NO contact
6	Relay	Relay common contact
7	PLC output	Busy
8	PLC output	End of measurement
9	PLC output	Measuring error
10	PLC output	<
11	PLC output	Device program 0 mirrored
12	PLC output	=
13	PLC output	Device program 1 mirrored
14	PLC output	>
15	PLC output	DANGER
16	PLC output	Device program 2 mirrored
17	PLC output	Device program 3 mirrored
18	PLC	+ 24 V External
19	PLC	+ 24 V External
20	PLC	Ground 24 V External
21	PLC input	START / STOP measurement
22	PLC input	Comparator ON / OFF
23	PLC input	Remove load (cooling curve)
24	PLC input	Spare 1
25	PLC input	START printer
26	PLC input	Save device program
27	PLC input	Spare 2
28	PLC input	Device program 0
29	PLC input	Device program 1
30	PLC input	Device program 2
31	PLC input	Device program 3
32	PLC input	Spare 3
33	Not used	
34	Pyrometer	+ 10 V Analog input
35	Pyrometer	Ground, FE
36	Foot switch	NO contact
37	Foot switch	NO contact, DGND
Shell	Shield	Protective ground

37-pin min sub-D
View towards socket
Connector shell: PE potential
Mating connector: Model 9900-V165

5 Operating instructions in brief

After switch on the instrument, the operating language can be selected in the instrument identification menu.

Pressing both arrow buttons simultaneously opens the configuration program. ENTER confirms the selected menu option. ESC can be used to return from any option in the configuration menu back to the next menu option down. If a value needs to be changed e.g. limit, arrows appear above the START/STOP buttons to move the cursor to the left/right. The numerical value is changed using the up/down arrow buttons (on the right-hand side) on the front panel.

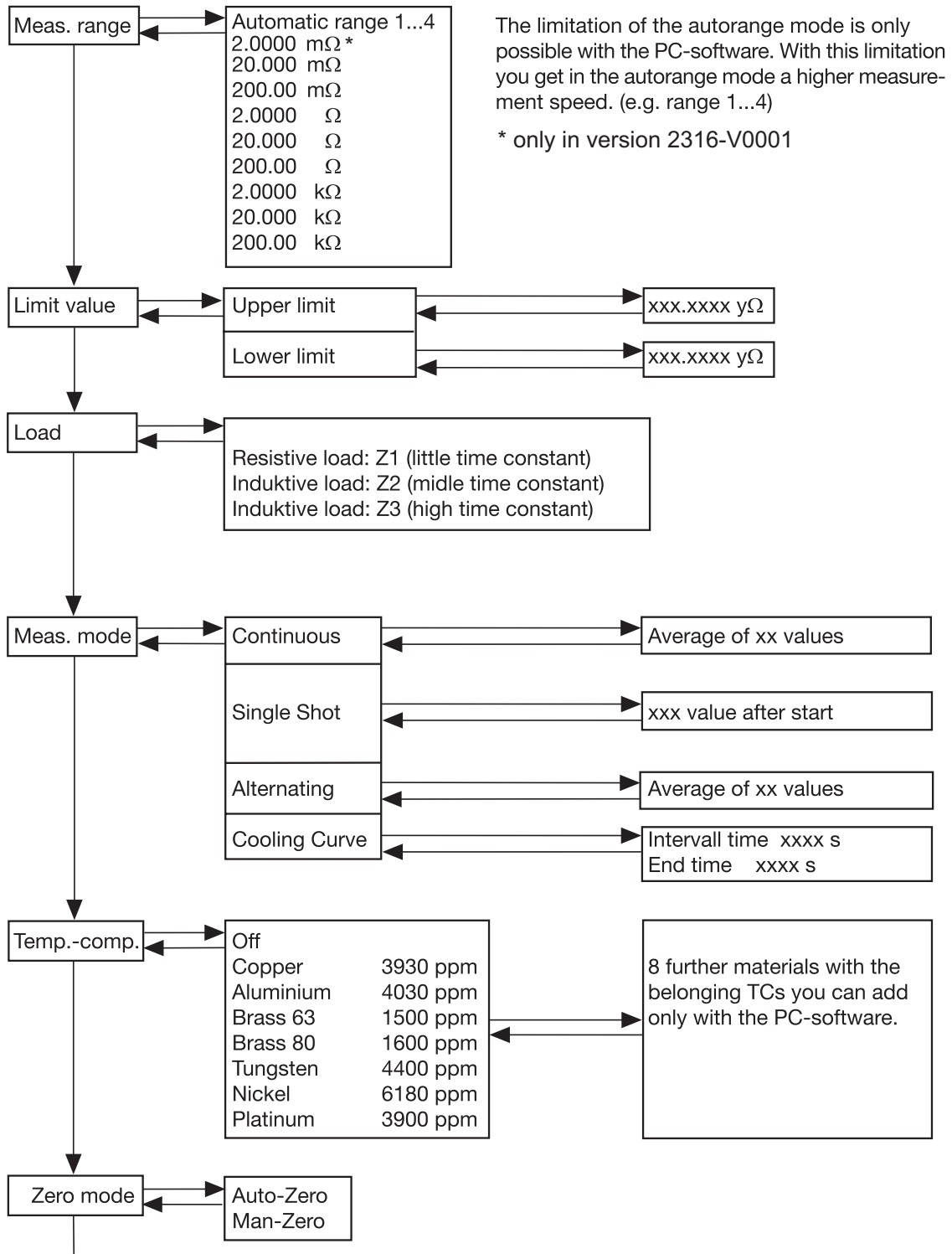

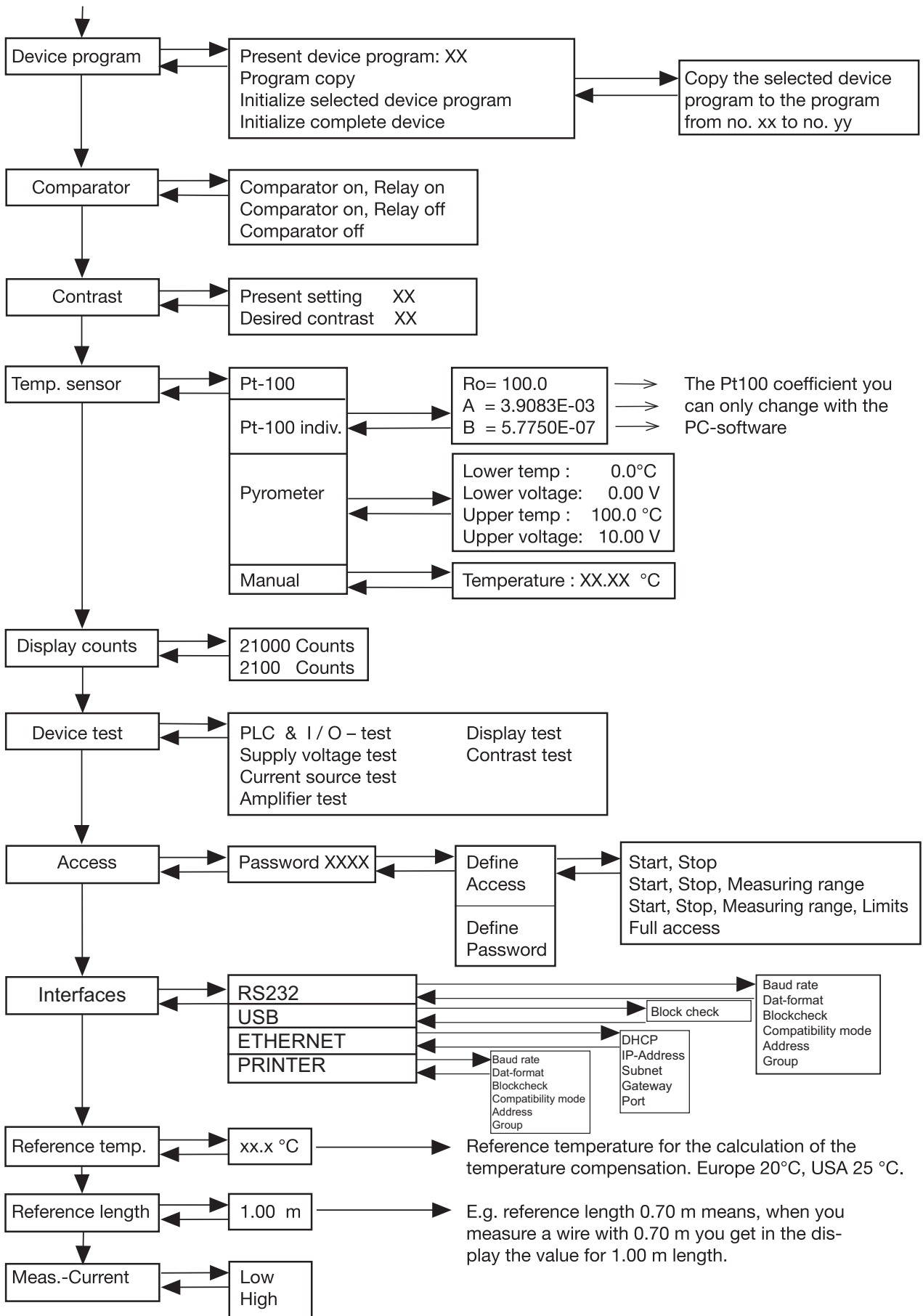

6 Operation

6.1 Meaning of the individual display segments

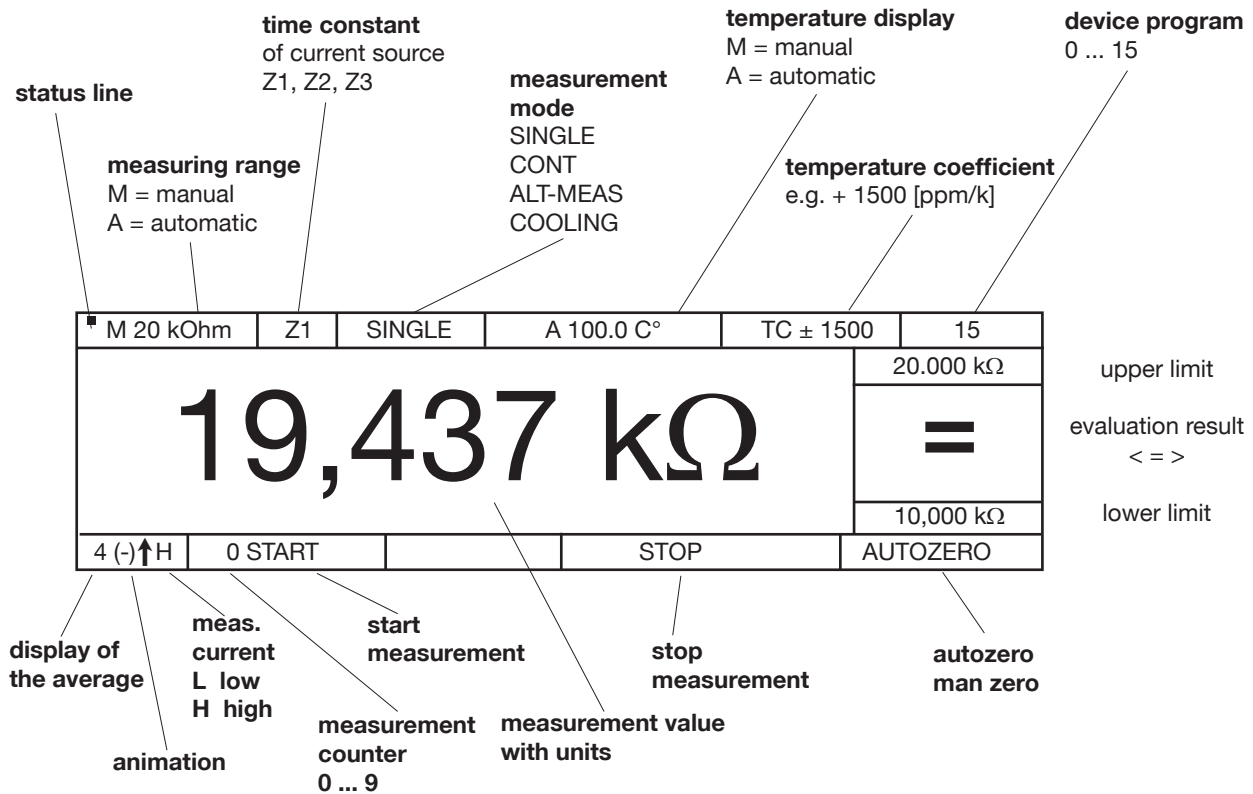

Limits and the evaluation result are only displayed when the comparator is enabled. When a measurement is in progress, the measurement counter increments from 0 to 9, changing whenever a new measurement result is available.

Danger warnings and error messages flash.

The animation indicator (-) flashes at second intervals to show that the meter is running and performing a measurement.

6.2 Start-up menu

The first menu is displayed after power up:

	RESISTOMAT 2316 VERSION: SERIAL NUMBER SOFTWARE VERSION CAL-NUMBER		
	LANGUAGE	TEST	

If LANGUAGE is not pressed within 3 seconds, the meter goes automatically into the Measurement menu. NEXT switches to the Measurement menu immediately.

Note:



If both buttons are pressed   simultaneously in this menu within the 3 seconds, the Service menu opens.

SERVICE MENU			
PASSWORD XXXX INITIALIZE DEVICE LOAD BASIC CALIBRATION			
220	ENTER	ESCAPE	SERVICE

This menu is protected by a secret password and can only be accessed by service personnel.

The following screen is displayed if LANGUAGE is pressed:

DEUTSCH ENGLISH FRANCAIS ITALIANO ESPANOL			
ENTER		ESCAPE	

Selection bar has inverse display, press  , ENTER to select and progress to menu

6.3 Configuration menu

If the $\uparrow\downarrow$ buttons are pressed simultaneously, the instrument goes into the configuration state and displays menu 5.

Menu 5 has three pages.

10	MEASURING RANGE	20 mΩ	\downarrow
20	LIMIT VAL.	10.000 mΩ, 20.000 mΩ	
30	LOAD	RESISTIVE LOAD: Z1	
40	MEASURING MODE	CONTINUOUS (1)	
50	TEMP. COMPENSAT.	OFF	
60	ZERO MODE	MAN ZERO	
MENU 5		ENTER	ESCAPE

Selection bar has inverse display. Press $\uparrow\downarrow$ to move selection bar, ENTER to select and proceed to menu 10 - 170, and ESCAPE to return setting to original value. The menu has a rolling display: after 170 comes 10; if you are in the bottom line, pressing \downarrow displays the next page with the cursor in the top line. The same happens in reverse when scrolling up. The arrow in the top right corner \downarrow indicates that this is the first menu page.

70	DEVICE PROGRAM	CURR.PRG.:0	$\downarrow\uparrow$
80	COMPARATOR	CO ON, REL ON DYNA	
90	CONTRAST	60 %	
100	TEMPERATURE SENSOR	PT-100 INDIV	
110	DISPLAY COUNTS	21000 DIGITS	
120	DEVICE TEST		
MENU 5		ENTER	ESCAPE

$\downarrow\uparrow$ shows that this is the second menu page.

140	ACCESS	NO RESTRICTION	
150	SERIAL INTERFACE	9k8, 8n1, B0, G00, I00	
160	REFERENCE TEMP	20 C°	
170	REF. LENGTH	1.00 m	
180	MEASUREMENT CURR	LOW	
MENU 5		ENTER	ESCAPE

\uparrow shows that this is the last menu page.

6.4 Measurement menu

6.4.1 Measurement mode

M 20 kOhm	Z1	SINGLE	A 100.0 C°	TC ± 1500	15
<h1>19.437 kΩ</h1>					15.000 kΩ
					>
					10.000 kΩ
(-)	0 START		STOP	AUTOZERO	

Limits and the evaluation result are only displayed when the comparator is enabled. When a measurement is in progress, the measurement counter increments from 0 to 9, changing whenever a new measurement result is available. Danger warnings and error messages flash. The animation indicator (-) flashes at second intervals to show that the meter is running and performing a measurement.

M 20 kOhm	Z1	SINGLE	A 100.0 C°	TC ± 1500	15
<h1>19.437 k $\frac{\Omega}{m}$</h1>					15.000 kΩ
					>
					10.000 kΩ
(-)	0 START		STOP	AUTOZERO	

The units „Ohms per meter, Ohm/km, Ohm/ft und Ohm/kft“ can be selected as an alternative.

Over-range indication

M 20 kOhm	Z1	SINGLE	A 100.0 C°	TC ± 1500	15
<h1><< >></h1>					
(-) 0	START		STOP	AUTOZERO	

6.5 Description of the individual setup menus

6.5.1 Measuring range

* SELECT MEASURING RANGE ↓				
AUTOMATIC (2 mOhm to 200 kOhm)				
2 mOhm				
20 mOhm				
200 mOhm				
MENU 10	ENTER		ESCAPE	MEAS RANG

Selection bar has inverse display. Press $\uparrow\downarrow$ to move selection bar, ENTER to select, and ESC to return to menu 5 without making a change. The arrow in the top right corner ↓ indicates that this is the first menu page.

The measuring range can also be changed while measurement is in progress using the $\uparrow\downarrow$ buttons in continuous measurement mode with Z1 and single shot mode with Z1, but in neither case with time constant Z2 or Z3 selected. Selecting AUTOMATIC in conjunction with MAN ZERO is pointless, because zeroing is only performed in one range in this case. Automatic mode is not possible with time constant Z2 or Z3.

This is because high induction voltages can occur when the range is switched for inductive devices under test. Purely resistive devices under test can be measured with Z1.

SELECT MEASURING RANGE ↓↑				
2 Ohm				
20 Ohm				
200 Ohm				
2 kOhm				
MENU 10	ENTER		ESCAPE	MEAS RANG

Selection bar has inverse display. Press $\uparrow\downarrow$ to move selection bar, ENTER to select. Press ESC to return to menu 5 without making a change. The arrows in the top right corner ↓↑ indicate that this is the second menu page.

* In order to speed up measurement times in automatic mode (measuring-range selection), the automatic range can be restricted using the PC software (e.g. 20 mΩ to 20 Ω).

SELECT MEASURING RANGE ↑				
20 kOhm 200 kOhm				
MENU 10	ENTER		ESCAPE	MEAS RANG

Selection bar has inverse display. Press \uparrow \downarrow to move selection bar, ENTER to select. Press ESC to return to menu 5 without making a change. The arrow in the top right corner \uparrow indicates that this is the last menu page.

6.5.2 Limits

LIMIT DEFINITION				
UPPER LIMIT: 2 Ohm				
LOWER LIMIT: 1 Ohm				
MENU 20	CHANGE		ESCAPE	LIMIT

ENTER UPPER LIMIT				
PRESENT MEAS. RANGE: AUTOMATIC				
002.00 Ohm				
MENU 20	ESCAPE		→	LIMIT

The cursor sits over the first 0. Pressing \uparrow \downarrow increases or decreases the numerical value, while \rightarrow moves the cursor one position to the right within the input field. With the cursor directly over „Ohm“, \uparrow \downarrow switches between m and k.

The limit is only saved when ENTER is pressed with the cursor in this position.

The lower limit is entered in the same way.

Note: According the evaluation limit values to the measurement value the PLC outputs respectively relays (< = >) activates. With a measurement error an evaluation is not possible and **no** PLC output respectively relays (< = >) activates.

6.5.3 Load selection

SELECT LOAD				
RESISTIVE LOAD: Z1				
INDUCTIVE LOAD: Z2				
INDUCTIVE LOAD: Z3				
MENU 30	ENTER		ESCAPE	LOAD

Selection bar has inverse display. Press \uparrow \downarrow to move selection bar, ENTER to select and return to menu 5, and ESC to return to menu 5 without making a change.

Selection of LOAD / TIME CONSTANTS Z1, Z2, Z3

This is used to select the time constant Z of the current regulator:

Z1 is set for purely resistive devices under test.

The time constants Z2, Z3 are selected for devices under test that have an inductive component. The instrument does not automatically detect inductive devices under test. For time-critical applications, one can use trial and error to find out whether a faster measurement is possible by selecting a shorter time constant. Start with the longest time constant Z3 and select the next shorter time constant Z2. If the same measurement result is obtained, you can then select the shorter time constant for all further measurements. Always short-circuit the device under test before disconnecting it.

For Z2 and Z3, the measuring range cannot be changed while the measurement is in progress.



Danger warnings for Z2, Z3

A DANGER warning flashes in the display after pressing START. The DANGER warning is displayed during the measurement and for one second after pressing the STOP button. Just because the danger warning is no longer displayed does not mean there is no longer any risk. Always short-circuit the device under test before disconnecting it.

Inadmissible instrument settings

The time constants Z2, Z3 cannot be used in conjunction with automatic measuring range and alternating measurement mode.

6.5.3.1 Handling inductive loads e.g. reactors, cables on reels, motors, coils, transformers

	 DANGER
<p>The instrument has two measurement inputs connected in parallel; only one of these inputs must be used at any one time. No leads must be plugged into the unused connector for safety reasons. The unused circular socket must be covered with the cap supplied.</p> <ul style="list-style-type: none"> • Before starting any measurement, make sure that the device under test does not carry an external voltage (e.g. mains voltage, voltage generated by a rotating motor etc.). • Take care when handling inductive devices under test. By the physical nature of inductive devices, life-threatening induction voltages can be generated when the test current is disconnected. • Dangerous induction voltages can occur if <ul style="list-style-type: none"> • The connectors are removed from the socket • The test current (measuring range) is changed or switched off (STOP). • The leads break • The connections on the device under test are loose • The instrument is switched off during the measurement • The power fails during the measurement • The test current changes for whatever reason • A fuse blows • An inductive device under test must not be connected or disconnected in the START condition. <p>• Always short-circuit the device under test before disconnecting.</p>	

Protection circuit / Discharge circuit

This is an instrument protection circuit. The constant current source is protected by a fuse, an overvoltage arrester and other measures for protecting against external voltages. If external voltages greater than 90 V are accidentally input to the instrument, the overvoltage arrester actuates, and the 10 A test-current fuse may blow. Before changing the fuse, make sure that no external voltages are still applied to the instrument. Remove the mains lead and short-circuit the device under test. Always replace the fuse with a fuse of the same type. Never select a fuse with a higher rated current or a different time characteristic.

The instrumentation amplifier is also protected against external voltages. A replaceable fuse is not fitted here.

Note: The input voltage protection is designed for voltages up to 400 V_{rms}. Measurements with external voltage (e.g. 230 V_{rms} or 400 V_{rms}) at the test object are not possible.

The circuit diagram for the protection circuit is shown below.

The diode provides a short-circuit for an induction current and discharges an inductance down to a residual voltage of about 3 V. Even though particularly high-power diodes are used, sometimes there may be a problem at the end of the measurement (when disconnecting) if the device under test has a particularly high inductance. In addition, the device under test cannot be discharged if the test-current fuse has blown. **Therefore for safety reasons, short-circuit the device under test before disconnecting it.**

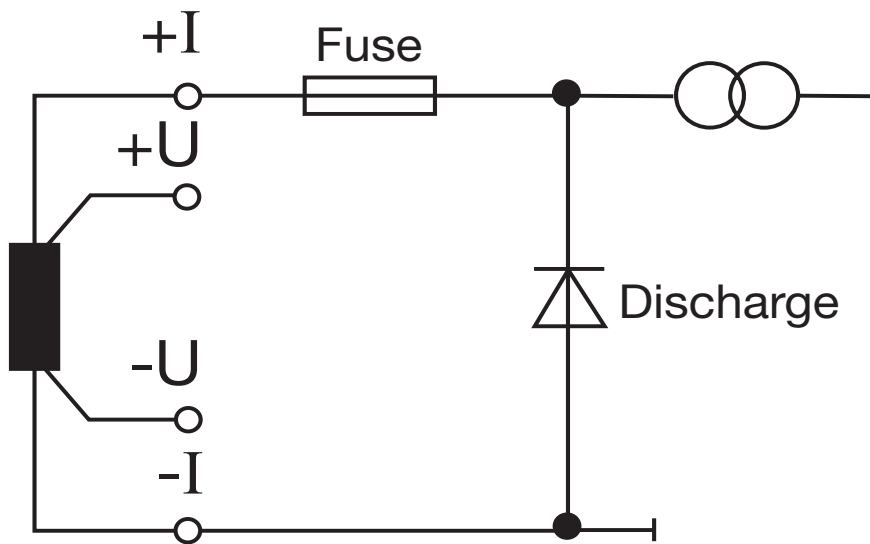

6.5.4 Measurement mode

SELECT MEASURING MODE ↓			
CONTINUOUS			
SINGLE SHOT			
ALTERNATING			
COOLING CURVE			
MENU 40	NEXT		ESCAPE MEAS MODE

Use ↑ ↓ to move the selection bar, ENTER to select

SELECT MEASURING MODE ↑			
FAST MEASURE			
MENU 40	NEXT		ESCAPE MEAS MODE

Use ↑ ↓ to move the selection bar, ENTER to select

6.5.4.1 Continuous operation

* ARITHMETIC AVERAGING CONTIN. MEASUREMENT			
AVERAGE VAL FRM 3 MEAS. VALS			
MENU 41	CHANGE		ESCAPE CONTINUO

Continuous operation means that the test current is switched on when the START button is pressed and not switched off until the STOP button is pressed. Mean values from n measurements are displayed. The first digitization takes about 550 ms (Z1, MAN ZERO, N=1), and subsequent digitization's about 210 ms each. The settling time depends on the time constant Z selected. For Z2 and Z3, the measuring range cannot be changed using the ↑ ↓ buttons while testing is in progress.

Pressing CHANGE displays the following screen:

ARITHMETIC AVERAGING CONTIN. MEASUREMENT			
AVERAGE VAL FRM 03 MEAS. VALS			
MENU 41	ESCAPE		→ CONTINUO

The cursor sits over the first zero. Pressing ↑ ↓ increases or decreases the numerical value, while → moves the cursor one position to the right within the input field. After selecting the value, press enter to save the value and close the menu.

* If the measurement display flickers, averaging over n-values can produce a constant display.

6.5.4.2 Single shot

MEASURING MODE: SINGLE SHOT				
* N-TH MEAS VAL AFTER START WILL EVALUATED				
N=1				
MENU 42	CHANGE		ESCAPE	CONTINUO

Single shot means that although all measurements are displayed, only the n'th measurement reading is saved and compared with the limits (comparator). Then the current source is switched off. The first digitization takes about 400 ms (Z1, MAN ZERO, N=1), and subsequent digitization about 100 ms each. The settling time also depends on the time constant Z selected however. For Z2 and Z3, and depending on the device under test, N needs to be set much higher; a correct result is not obtained with N=1. For Z2, Z3 the measuring range cannot be changed while the measurement is in progress.

Pressing CHANGE displays the following screen:

MEASURING MODE: SINGLE SHOT				
N-TH MEAS VAL AFTER START WILL EVALUATED				
N=0				
MENU 42	ESCAPE		→	SINGLE

The cursor sits over the first zero. Pressing \uparrow \downarrow increases or decreases the numerical value, while \rightarrow moves the cursor one position to the right within the input field. After selecting the value, pressing ENTER saves the value and closes the menu.

- * This function is usually only required for inductive devices under test (coils). Since the instrument does not detect automatically when the magnetic field of the device under test is constant $(\dot{\gamma} = \frac{L}{R})$,

the measurement time (n'th reading) must be found empirically.

6.5.4.3 Alternating measurement mode

MEASURING MODE: ALTERNATE				
AVERAGE VAL FROM 3 MEAS. VALS				
MENU 44	CHANGE		ESCAPE	ALT MEAS

Alternating measurement mode means that the test current is switched on when the START button is pressed and not switched off finally until the STOP button is pressed. The current source is switched on and off continuously during the measurement to suppress any thermal EMFs, so that the instrument remains permanently correctly “zeroed”. Select this measurement mode for ultra precise measurements that are not time critical.



Mean values of n measurements are displayed. One digitization takes about 2 s (Z1, N=1). While the measurement is in progress, the animation (-) indicator displayed on the lower left flashes at second intervals to show that the measurement is running.

This setting cannot be used in conjunction with time constants Z2, Z3 or with an inductive load.

The setting MAN ZERO/AUTOZERO is ignored.

Pressing CHANGE displays the following screen:

MEASURING MODE: ALTERNATE				
AVERAGE VAL FROM 003 MEAS. VALS				
MENU 44	ESCAPE	→		ALT MEAS

The cursor sits over the first zero. Pressing   increases or decreases the numerical value, while → moves the cursor one position to the right within the input field. After selecting the value, pressing ENTER saves the value and closes the menu.

6.5.4.4 FAST MEASURE

In the fast measure mode the measuring time with ohmic samples (without any inductivity) is approx. 240 ms.

The fast measure is only possible in a reduced functionality.

First following settings must be done:

Autorange OFF (menu 10)
(only man. range selection possible)

Resistive Load Z1 (menu 30)

Man Zero (menu 60)

6.5.4.5 Cooling curve

The Cooling curve measurement mode is allowed in conjunction with all times constants, and manual and automatic zero offset.

It is not allowed, however, in conjunction with comparator, automatic measuring range and automatic temperature compensation. The setting OHM/m is also ignored. Nor in this case is it possible to change the measuring range during the measurement for time constant Z1.

MEASURING MODE COOLING CURVE				
INTERVAL TIME: 1S				
END TIME: 100 S				
DISCARD 0 MEAS VALS AFTER START				
AVERAGE VAL FROM 2 MEAS. VALS				
MENU 43	CHANGE		ESCAPE	COOL

Pressing CHANGE displays the following screen:

MEASURING MODE COOLING CURVE				
INTERVAL TIME: 0001S				
END TIME: 100 S				
DISCARD 0 MEAS VALS AFTER START				
AVERAGE VAL FROM 2 MEAS. VALS				
MENU 43	ESCAPE		→	COOL

The cursor sits over the first zero. Pressing \uparrow \downarrow increases or decreases the numerical value, while \rightarrow moves the cursor one position to the right within the input field. After selecting the value, pressing ENTER saves the value and closes the menu.

The INTERVAL TIME is the time between two measurements. It must always be shorter than the END TIME.

MEASURING MODE COOLING CURVE				
INTERVAL TIME: 1S				
END TIME: 100 S				
DISCARD 0 MEAS VALS AFTER START				
AVERAGE VAL FROM 2 MEAS. VALS				
MENU 43	CHANGE		ESCAPE	COOL

The END TIME is the time at which the measurement is terminated. Shown later as MAX in the display. It must always be greater than the INTERVAL TIME. The interval time is the time between two measurements.

Pressing CHANGE displays the following screen:

MEASUREMENT MODE COOLING CURVE				
INTERVAL TIME: 1S				
END TIME: 0100 S				
DISCARD 0 MEAS VALS AFTER START				
AVERAGE VAL FROM 2 MEAS. VALS				
MENU 43	ESCAPE		→	COOL

The cursor sits over the first zero. Pressing \uparrow \downarrow increases or decreases the numerical value, while \rightarrow moves the cursor one position to the right within the input field. After selecting the value, pressing ENTER saves the value and closes the menu.

MEASUREMENT MODE COOLING CURVE				
INTERVAL TIME: 1S				
END TIME: 0100 S				
DISCARD 0 MEAS VALS AFTER START				
AVERAGE VAL FROM 2 MEAS. VALS				
MENU 43	CHANGE		ESCAPE	COOL

Depending upon size of inductance resp. time constant $\tilde{\tau} (\tilde{\tau} = \frac{L}{R})$ the first values after start are between zero and the real value. With this setting the first values can be discard.

After closing menu 43, you return via menu 5 (now select measuring range) to measurement mode. With manual zero suppression selected, the display looks as follows:

M 2 mOhm	Z1	COOL		15
				DATA LOG
				ACT: STOP MAX: 100s
	LOAD REM		TARE	MAN-ZERO

TARE starts the zero offset process as normal. The time starts running from when LOAD REM is pressed (remove load, end of heating phase for device under test), and the previous values held in the data logger are deleted at this point in time. The instrument can also receive the LOAD REM command via the PLC or RS232 interface.

MEASUREMENT MODE COOLING CURVE				
INTERVAL TIME: 1S				
END TIME: 0100 S				
DISCARD 0 MEAS VALS AFTER START				
AVERAGE VAL FROM 2 MEAS. VALS				
MENU 43	CHANGE		ESCAPE	COOL

Accordant the value stability you can enter the no. of averages for one measurement point.

M 2 mOhm	Z1	COOL		15
1.4379 mΩ				ACT: 24s MAX: 100s
(-)	0 START	STOP		AUTOZERO

START launches the actual resistance measurement (with AUTOZERO set, there may be a slight delay of about 0.25 s to allow for the zero measurement) and the measurements are saved in the data logger (up to 999 values). The measurement can be stopped with STOP and resumed with START. The results of a second series of measurements are recorded in the data logger under cycle B etc., so devices with more than one winding can be tested.

The following screen is displayed after pressing the STOP button twice, or once the MAX time (END TIME) has elapsed.

After double pressing of the STOP key or after max. time (ENDTIME) you get following display.

M 2 mOhm	Z1	COOL		15
				DATALOG
				ACT: STOP MAX: 100s
	B-END		TARA	MAN-ZERO

With the arrow button \uparrow you can view the values.

NUM	REL.TIME	MEAS VALUE	CYCLE	
1	2 s	1.4379 mOhm	A	↑
2	3 s	1.4368 mOhm	A	
3	4 s	1.4354 mOhm	A	
4	13 s	1.2214 mOhm	B	↓
PRINT	ESCAPE			

Use the arrow buttons \uparrow \downarrow to view the measured values.

The REL TIME is the time elapsed after pressing LOAD REM.

If you have selected PRINTER as the interface, you can now print out the table in full.

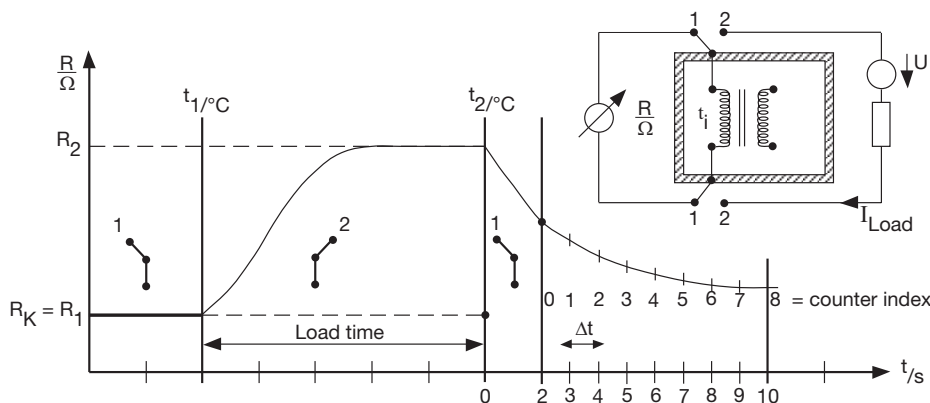

Since the first resistance value cannot be measured until after a short delay after switching off the load current, the actual resistance at the time when the load was removed can only be found by extrapolating the cooling curve. The add-on PC software package 2316-P001 can be purchased to help perform this calculation.

6.5.5 Temperature compensation

SELECT TEMPERATURE COMPENSATION				
OFF				
*	COPPER	(+3930 PPM/K)		
	ALUMINIUM	(+4030 PPM/K)		
	BRASS 63	(+1500 PPM/K)		
	MENU 50	ENTER	ESCAPE	TEMP.COMP

Selection bar has inverse display. Press \uparrow \downarrow to move selection bar, ENTER to select, and ESC to return to the menu.

Enabling temperature compensation changes the display value. The value displayed is the resistance that a device made of this material would have if its temperature were e.g. 20°C. The instrument converts the resistance in accordance with DIN VDE 0472:

$$R(T_0) = R(T) \frac{1}{1 + \frac{TK}{1\,000\,000} * (T - T_0)}$$

where

R(T) is the resistance measured at temperature T

R(T₀) is the resistance value at the reference temperature T₀ (normally 20°C)**

TC is the temperature coefficient in ppm/K.

SELECT TEMPERATURE COMPENSATION				
BRASS 80 (+1600 PPM/K)				
	TUNGSTEN	(+4400 PPM/K)		
	NICKEL	(+6180 PPM/K)		
	PLATINUM	(+3900 PPM/K)		
	MENU 50	ENTER	ESCAPE	TEMP.COMP

It is possible to enter another 8 custom TCs (max. 8 materials, text and numerical value) in the instrument via the interface using PC software. These are then displayed on the two subsequent pages.

* A TC of +3930 ppm/k means that the resistance of the device under test will increase by 0.393% per degree C.

** In Europe, the specified test values are normally referred to 20 °C, in USA to 23 °C or 25 °C. This reference temperature can be changed in menu 160.

6.5.6 Autozero / Man-Zero

SELECT AUTOZERO				
<div style="border: 1px solid black; padding: 2px;"> AUTOZERO MAN ZERO </div>				
MENU 60	ENTER		ESCAPE	ZERO CFG

Press $\uparrow \downarrow$ to move selection bar, ENTER to select, and ESC to return to the measurement menu.

When Autozero is enabled, after pressing the START button the voltage across the U terminals is detected and zeroed n times, initially with the current still off. The measurement is made using the selected measurement mode and the selected load. This zeroing procedure is performed to compensate for the thermal EMF in the measurement circuit. Then the actual measurement is performed n times with the measurement current switched on. The connectors must be in thermal equilibrium for compensation of thermal EMFs to work perfectly. If possible, press STOP before changing the device under test. AUTOZERO is shown in the display.

Hint: At inductive test objects please use only MAN ZERO. The remain charge at the coil gives sometimes a wrong zero point.

SELECT AUTOZERO				
<div style="border: 1px solid black; padding: 2px;"> AUTOZERO MAN ZERO </div>				
MENU 60	ENTER		ESCAPE	AUTOZERO

If MAN-ZERO is selected, press STOP twice in the measurement menu. The following screen is displayed for example:

M 200 kOhm	Z1	CONTINUO		TC OFF	15
TARE: PLEASE CONTACT TEST SAMPLE					
	TARE		ESCAPE	MAN-ZERO	

Pressing the TARE button detects and zeroes the voltage lying across the U terminals. The measurement current has not been switched on yet. Always make sure that you have selected the correct measuring range before zeroing. Automatic selection of the measuring range makes little sense here, but is permitted.

6.5.7 Device program

SELECT DEVICE PROGRAM				
PRESENT DEVICE PROGRAM: 0				
PROGRAM COPY				
INITIALIZE SELECTED DEVICE PROGRAM				
INITIALIZE COMPLETE DEVICE				
MENU 70	CHANGE		ESCAPE	MEAS PROG

Pressing the CHANGE button displays the following screen:

SELECT DEVICE PROGRAM				
PRESENT DEVICE PROGRAM: █				
PROGRAM COPY				
INITIALIZE SELECTED DEVICE PROGRAM				
INITIALIZE COMPLETE DEVICE				
MENU 70	ESCAPE		→	MEAS PROG

Code
4632

Pressing \uparrow / \downarrow increases or decreases the numerical value, while \rightarrow moves the cursor to the right. Always enter a 2-digit number with leading zeros. ENTER loads the selected program.

SELECT DEVICE PROGRAM				
PRESENT DEVICE PROGRAM: 0				
PROGRAM COPY				
INITIALIZE SELECTED DEVICE PROGRAM				
INITIALIZE COMPLETE DEVICE				
MENU 70	ENTER		ESCAPE	MEAS PROG

The following screen is displayed after pressing the ENTER button:

COPY DEVICE PROGRAM				
PRESENT DEVICE PROGRAM TO PROGRAMS				
FROM NO.: 1				
TO NO.: 1				
COPY				
MENU 71	ENTER		ESCAPE	PROG COPY

After pressing ENTER

COPY DEVICE PROGRAM				
PRESENT DEVICE PROG. (1) TO PROGRAMS				
FROM NO.: 01				
TO NO.: 1				
COPY				
MENU 71	ESCAPE		→	PROG COPY

Pressing \uparrow / \downarrow increases or decreases the numerical value, while \rightarrow moves the cursor to the right. Always enter a 2-digit number with leading zeros.

The value for TO NO is entered in the same way.

Example: You copy the PRESENT device program no. 1 to program no. 2 up to no. 7 inclusive.

Numbers from 00 to 15 are allowed.

6.5.8 Comparator

SELECT COMPARATOR MODE				
* COMPARATOR ON, RELAY ON				
COMPARATOR ON, RELAY OFF				
COMPARATOR OFF				
MENU 80	ENTER		ESCAPE	COMPARAT.

The following menu is displayed if the comparator is enabled:

SELECT COMPARATOR RESET MODE				
STATIC				
DYNAMIC				
MENU 81	ENTER		ESCAPE	COMPARAT.

Use $\uparrow \downarrow$ to move the selection bar, ENTER to select

Static means that the comparator is reset immediately before the measurement starts. After pressing STOP, the evaluation result (display, PLC, relay if applic.) continues to be available until START is pressed again. Before the measurement starts the comparator will be reset immediately.

STATIC means that the first exceedance of the limit is stored as an assessment value although other measurement values might be within the limits.

Example: Limit value LL 1 Ω , UL 2 Ω

1. Value	1.5 Ω	→	Comp. =
2. Value	3 Ω	→	Comp. >
3. Value	1.5 Ω	→	Comp. >

After a new measurement start

1. Value	1.5 Ω	→	Comp. =
2. Value	0.5 Ω	→	Comp. <
3. Value	1.5 Ω	→	Comp. <

DYNAMIC means that the evaluation result follows dynamically immediately after the measurement result.

* With the comparator enabled, the optocoupler outputs for < = > are always active, even if the relay outputs are disabled.

6.5.9 Contrast

CONTRAST SETTING				
PRESENT SETTING: 50				
DESIRED CONTRAST: 50				
MENU 90	CHANGE		ESCAPE	CONTRAST

The following screen is displayed after pressing the CHANGE button:

CONTRAST SETTING				
PRESENT SETTING: 50				
DESIRED CONTRAST: 50				
MENU 90	ESCAPE		→	CONTRAST

Pressing \uparrow / \downarrow increases or decreases the numerical value, while \rightarrow moves the cursor to the right. Always enter a 2-digit number with leading zeros.

6.5.10 Temperature sensor

SELECT TEMPERATURE SENSOR				
PT-100 PT-100 INDIV PYROMETER MANUAL				
MENU 100	NEXT		ESCAPE	TEMP SENS

If PT-100 is selected, the following screen is displayed for information; values cannot be changed.

PT-100 COEFFICIENTS (DIN EN 60751) (FIX)				
$R(T) = R_0 * (1 + A*T + B*T^2)$ R0 = 100.0 A = 3.9083E-03 B = -5.7750E-7				
MENU 101	NEXT		ESCAPE	TEMP SENS

Permitted temperature range: 0°C to + 100 °C

If PT-100 INDIV is selected, the following screen is displayed for information:

* PT-100 COEFFICIENTS (DIN EN 60751) (PC-INTERFACE)				
$R(T) = R_0 * (1 + A*T + B*T^2)$ R0 = 100.0 A = 3.9083E-03 B = -5.7750E-7				
MENU 102	NEXT		ESCAPE	TEMP SENS

The custom values to be entered only by PC interface are shown.

Permitted temperature range: 0°C to + 100°C

- * The A-B factors measured for the PT 100 sensor and the value for Ro (e.g. DKD certificate) can be transferred to the instrument using the PC software 2316-P001 (purchased separately). This enables accurate temperature measurement.

The following screen is displayed if PYROMETER is selected:

PYROMETER CALIBRATION				
LOWER TEMP:	0,0	°C	(MAX 999.9 °C)	
LOWER VOLT.:	0.00	V	(MAX 10 V)	
UPPER TEMP:	100,0	°C	(MAX 999.9 °C)	
UPPER VOLT.:	10	V	(MAX 10 V)	
MENU 103	CHANGE		ESCAPE	PYROMETER

Pressing CHANGE displays the following screen:

PYROMETER CALIBRATION				
LOWER TEMP:	00.00	°C	(MAX 999.9 °C)	
LOWER VOLT.:	0,00	V	(MAX 10 V)	
UPPER TEMP:	100,0	°C	(MAX 999.9 °C)	
UPPER VOLT.:	10	V	(MAX 10 V)	
MENU 103	ESCAPE		→	PYROMETER

Pressing \uparrow \downarrow increases or decreases the numerical value, while \rightarrow moves the cursor to the right. Always enter a 5-digit number with leading zeros.

Note: Permitted voltage range 0 to 10 V

Example:

A pyrometer outputs a voltage of 0 V at 0 °C and a voltage of 10 V at 100 °C:

the display above is then correct for this sensor. A pyrometer model 2328-Z001 is available as an extra device.

The following screen is displayed if MANUAL is selected:

SETUP AMBIENT TEMPERATURE				
LOWER TEMP: 20.00 °C (0.0 ... 100.0 °C)				
MENU 104	CHANGE		ESCAPE	MANUAL

Pressing CHANGE displays the following screen:

SETUP AMBIENT TEMPERATURE				
LOWER TEMP: 020.00 °C (0.0 ... 100.0 °C)				
MENU 104	ESCAPE		→	MANUAL

Pressing $\uparrow\downarrow$ increases or decreases the numerical value, while \rightarrow moves the cursor to the right. Always enter a 5-digit number with leading zeros.

6.5.11 Display counts

SELECT DISPLAY COUNTS				
* 21000 DIGITS				
2100 DIGITS				
MENU 110	ENTER		ESCAPE	MANUAL

Use $\uparrow\downarrow$ to move the selection bar, ENTER to select

Strictly speaking, the display counts up to 20999 or 2099.

- * If the last digit flickers because of interference, it is often useful to reduce the display counts.

6.5.12 Self test

The instrument has numerous built-in diagnostic functions, which you can use to check whether the instrument is working correctly, and for self-help troubleshooting.

DEVICE TEST ↓				
PLC & I/O - TEST SUPPLY VOLTAGE TEST CURRENT SOURCE TEST AMPLIFIER TEST				
MENU 120	ENTER		ESCAPE	DEVICE TEST

Use $\uparrow\downarrow$ to move the selection bar, ENTER to select.

DEVICE TEST ↑				
DISPLAY TEST CONTRAST TEST				
MENU 120	ENTER		ESCAPE	DEVICE TEST

Use $\uparrow\downarrow$ to move the selection bar, ENTER to select.

The following screen appears after selecting „PLC & I/O TEST“:

PLC & I/O - TEST ↓				
		(SMALLER - RELAY)		
OUTPUTS		001010010000000	→	
INPUTS		00000000010000	←	
		(STA/STO MEASUREMENT)		
MENU 121	SET		ESCAPE	I/O-TEST

Use the arrow buttons $\uparrow\downarrow$ to move the cursor to the right or left.

The present level of the control outputs is specified in the „OUTPUTS“ line. The screen above shows the status of the comparator. The SET button can be used to set the level to ON=1, while RESET can set the level to OFF=0.

Note: the status that the outputs are meant to have is specified here. The output status is measured in the instrument. If the actual status does not match the assumed status, check if any of the leads or connectors are open-circuit or short-circuit.

Please note the polarity of the output levels. The I/Os can be implemented in accordance with the American standard as an option.

The present status of the control inputs is shown in the „INPUTS“ line.

The following screen appears after selecting "SUPPLY VOLTAGE TEST".

SUPPLY VOLTAGE TEST				
<h1>PASS</h1>				
MENU 122			ESCAPE	U-TEST

If the screen don't appears one of internal supply voltages are off. Switch the device off and on and try it again.

The following screen appears after selecting "CURRENT SOURCE TEST".

CURRENT SOURCE TEST				
PLEASE REMOVE TEST LEADS				
NOTE THE SAFETY INSTRUCTIONS PRESS START AFTERWARDS				
MENU 123	START		ESCAPE	I-TEST

The following screen appears after a waiting period of 10 s.

CURRENT SOURCE TEST				
<h1>PASS</h1>				
MENU 123			ESCAPE	I-TEST

Note: If the current source test is without error result and the device nevertheless work ok, please change the current source fuse on the back panel.

NOTICE

Please read chapter "safety instructions"

Fuse: Super quick acting 10A fuse 6,3*32 mm, 600VAC, 50000A breaking capacity (or greater)
RS components #209-9383 (in Germany).
Use only this fuse.

The following display appears after selecting „Amplifier test“:

AMPLIFIER TEST				
PLEASE REMOVE TEST LEADS				
NOTE THE SAFETY INSTRUCTIONS PRESS START AFTERWARDS				
MENU 124	START		ESCAPE	AMP-TEST

The following display appears after selecting „Current source test“:

AMPLIFIER TEST				
<h1>PASS</h1>				
MENU 124	START		ESCAPE	I-TEST

After selecting „DISPLAY TEST“, all the characters of the display are run through from left to right. This test is terminated automatically after about 35 s.

After selecting „CONTRAST TEST“, the display contrast adjustment range is demonstrated. This test is terminated automatically after about 20 s.

6.5.13 Access to password

This is where one specifies whether the meter user can access all functions and settings of the instrument, or whether his access options are limited. On delivery, access is enabled for all settings.

ACCESS LEVEL				
PRESENT ACCESS POSSIBLE FOR FULL ACCESS PASSWORD XXXX				
MENU 141	ENTER		ESCAPE	ACCESS

Pressing the „ENTER“ button allows you to enter the password.

ACCESS LEVEL				
PRESENT ACCESS POSSIBLE FOR FULL ACCESS PASSWORD XXXX				
MENU 141	ENTER	→	ESCAPE	ACCESS

Use ↑↓ to increase or decrease the numerical value. Always enter a 4-digit number; the factory-set code is „6948“.

CHANGE PASSWORD AND ACCESS				
CHANGE ACCESS CHANGE PASSWORD				
MENU 141	NEXT		ESCAPE	ACCESS

Press ↑↓ to move selection bar.

The following screen appears after selecting “CHANGE ACCESS”.

ALLOW ACCESS TO				
START, STOP START, STOP, MEASURING RANGE START, STOP, MEASURING RANGE, LIMIT VALUES FULL ACCESS				
MENU 142	ENTER		ESCAPE	ACCESS

The current selection is highlighted. Press ↑↓ to move selection bar, ENTER to select.

The following screen appears after selecting „CHANGE PASSWORD“:

CHANGE PASSWORD				
PRESENT PASSWORD: 6948				
NEW PASSWORD: XXXX				
MENU 144	CHANGE			PASSWORD

Use ↑↓ to increase or decrease the numerical value. Always enter a 4-digit number.

CHANGE PASSWORD				
PRESENT PASSWORD: 6948				
NEW PASSWORD: XXXX				
MENU 144	CHANGE			PASSWORD

6.5.14 Interfaces

You can choose between different interfaces.,

SELECT INTERFACE				
RS232				
USB				
ETHERNET				
DRUCKER				
MENU 154	NEXT		ESCAPE	

Use ↑↓ to move the selection bar, NEXT to select, ESCAPE to return.

6.5.14.1 RS232 Interface

For the RS232 Interface various settings can be configured.

CONFIGURATION RS232 INTERFACE ↓				
BAUD RATE: 9600				
DAT-FORMAT: 8DATA, 1STOP, NO PARITY				
ADDRESS: 0				
GROUP: 0				
MENU 150	CHANGE		ESCAPE	RS232

Use ↑↓ to move the selection bar, CHANGE to select, ↓ indicates that there is a second page.

CONFIGURATION RS232 INTERFACE		(PRINTER)	↓
BAUD RATE:	9600		
DAT-FORMAT:	8DATA, 1STOP, NO PARITY		
ADDRESS:	0		
GROUP:	0		
MENU 150	ENTER	ESCAPE	RS232

To toggle between the possible setting of „BAUD RATE“ and „DAT-FORMAT“, use the $\uparrow\downarrow$ buttons. Press ENTER to select the highlighted setting.

CONFIGURATION RS232 INTERFACE		(PRINTER)	↓
BAUD RATE:	9600		
DAT-FORMAT:	8DATA, 1STOP, NO PARITY		
ADDRESS:	00		
GROUP:	0		
MENU 150	ESCAPE	--->	RS232

To set the numerical value of „ADDRESS“ and „GROUP“, use the $\uparrow\downarrow$ buttons. Always enter a 2-digit number. The valid range of values is 0 ... 99.

CONFIGURATION RS232 INTERFACE			↑
BLOCKCHECK:	OFF		
COMPATIBILITY MODE:	STANDARD		
MENU 150	CHANGE	ESCAPE	RS232

Use $\uparrow\downarrow$ to move the selection bar, CHANGE to select. \uparrow indicates that there is a first page: To toggle between the possible settings use the $\uparrow\downarrow$ buttons. Press ENTER to select the highlighted setting.

Compatibility mode „2318“ means that the old interface commands for the RESISTOMAT® model 2318 are recognized by the instrument. The RESISTOMAT® model 2316 provides functions that were not included in the RESISTOMAT® model 2318, however, and vice versa. Please only use the old commands when it cannot be avoided, and leave the instrument in the standard configuration as far as possible. More information is provided in the description of the interface commands.

6.5.14.2 USB Interface

CONFIGURATIIN USB				
BLOCKCHECK: OFF 57.6 KBAUD, 8N1, ADR 0, GRP 0				
MENU 151	CHANGE		ESCAPE	USB

To set the blockcheck press CHANGE and use the $\uparrow\downarrow$ buttons to toggle between ON/OFF and ESCAPE to return.

The second line with baud rate, dat-format addresses and group is fixed and can't be changed.

6.5.14.3 Ethernet Interface

ETHERNET SETUP ↓				
DHCP: OFF IP-ADR: 192.168.000.001 SUBNET: 255.255.000.000 GATEWAY: 192.168.110.254				
MENU 155	CHANGE		ESCAPE	ETHERNET

Use the $\uparrow\downarrow$ buttons to move the selection bar, CHANGE to select, ESCPAE to return, ↓ indicates that there is a second page.

DHCP (dynamic host configuration protocol) offers a complete solution for implementing DHCP servers, relay agents and clients for small local networks to large enterprises. It is suitable for use in high volume and high-reliability applications.

ETHERNET SETUP ↓				
DHCP: OFF IP-ADR: 192.168.000.001 SUBNET: 255.255.000.000 GATEWAY: 192.168.110.254				
MENU 155	<---		--->	ETHERNET

IP address, SUBNET, GATEWAY and PORT are changeable.

Press CHANGE and $\rightarrow\leftarrow$ to select the position that need to be changed, use $\uparrow\downarrow$ to set the numerical value.

ETHERNET SETUP ↑				
PORT: 0179 MAC-ADR: 00:30:f9:12:88:o5				
MENU 155	CHANGE		ESCAPE	ETHERNET

The MAC address is fixed.

6.5.14.4 Printer interface

The printer interface is a serial interface directly to a serial RS232 printer.

For the printer interface various settings can be configured.

CONFIGURATION RS232 INTERFACE		PRINTER		↓
BAUD RATE: 57600				
DAT-FORMAT: 8DATA, 1STOP, NO PARITY				
ADDRESS: 0				
GROUP: 0				
MENU 150	CHANGE		ESCAPE	RS232

Use ↑↓ to move the selection bar, CHANGE to select, ↓ indicates that there is a second page.

CONFIGURATION RS232 INTERFACE		PRINTER		↓
BAUD RATE: 57600				
DAT-FORMAT: 8DATA, 1STOP, NO PARITY				
ADDRESS: 0				
GROUP: 0				
MENU 150	CHANGE		ESCAPE	RS232

To toggle between the possible setting of „BAUD RATE“ and „DAT-FORMAT“, use the ↑↓ buttons. Press ENTER to select the highlighted setting.

CONFIGURATION RS232 INTERFACE		PRINTER		↓
BAUD RATE: 9600				
DAT-FORMAT: 8DATA, 1STOP, NO PARITY				
ADDRESS: 00				
GROUP: 0				
MENU 150	ESCAPE		--->	RS232

To set the numerical value of „ADDRESS“ and „GROUP“, use the ↑↓ buttons.

Always enter a 2-digit number.

The valid range of values is 0 ... 99.

Permanent printing

Setting PRINTER as interface that every valid measurement is sent to the printer. Depending on the device setting a large amount of data could be produced. Set the device and the printer to the greatest possible common transmission rate.

On demand printing

Set the device on single measurement. In this setting each measurement creates one printout. Address the "start printer" input via the IO interface. As long as this control signal is addressed the measurements will be printed.

The printout is left-aligned below one another.

Value without limit evaluation	Value with limit evaluation	
1.980 kΩ	1.443 kΩ	=
1.910 kΩ	1.252 kΩ	=
1.845 kΩ	1.168 kΩ	=
1.732 kΩ	0.799 kΩ	<
1.576 kΩ	0.622 kΩ	<
1.430 kΩ	0.619 kΩ	<
1.429 kΩ	0.632 kΩ	<
1.315 kΩ	0.654 kΩ	<
1.190 kΩ	1.324 kΩ	=
1.188 kΩ	1.588 kΩ	=
1.188 kΩ	1.588 kΩ	=
1.188 kΩ	1.588 kΩ	=
1.188 kΩ	1.588 kΩ	=
1.188 kΩ	1.588 kΩ	=

6.5.15 Reference temperature

REFERENCE TEMPERATURE				
PRESENT SETTING: 20.0 °C				
DESIRED TEMPERATURE: 20.0 °C (10°C ... 30°C)				
MENU 160	CHANGE		ESCAPE	REF.TEMP

Pressing the „CHANGE“ button displays the following screen:

SELECT REFERENCE TEMPERATURE				
PRESENT SETTING: 20.0 °C				
DESIRED TEMPERATURE: 20.0 °C (10°C ... 30°C)				
MENU 160	ESCAPE		→	REF.TEMP

Use ↑↓ to increase or decrease the numerical value. Always enter a 4-digit number;

Important note:

- If the reference temperature does not equal 20 °C, CAL is displayed in the bottom status bar.
- This temperature setting should not be changed if possible. In European countries the measured values are always referred to 20 °C.
In the USA, reference temperatures of 23 °C or 25 °C can be the norm.

6.5.16 Reference length

REFERENCE LENGTH		(0.1 ... 9999.99 m)		
PRESENT SETTING:		1.00 m		
DESIRED SETTING:		1.00		
SELECTION OF UNIT:		Ohm		
MENU 170	CHANGE		ESCAPE	REF.LENG

Use $\uparrow\downarrow$, ENTER to select.

The default reference length is 1m.

The following screen is displayed after pressing the CHANGE button:

REFERENCE LENGTH		(0.1 ... 9999.99 m)		
PRESENT SETTING:		1.00 m		
DESIRED SETTING:		0001.00 m		
SELECTION OF UNIT:		Ohm		
MENU 170	ESCAPE		→	REF.LENG

Use $\uparrow\downarrow$ to increase or decrease the numerical value.

REFERENCE LENGTH		(0.1 ... 9999.99 m)		
PRESENT SETTING:		1.00 m		
DESIRED SETTING:		1.00		
SELECTION OF UNIT:		Ohm		
MENU 170	CHANGE		ESCAPE	REF.LENG

Use $\uparrow\downarrow$, ENTER to select.

REFERENCE LENGTH		(0.1 ... 9999.99 m)		
PRESENT SETTING:		1.00 m		
DESIRED SETTING:		1.00		
SELECTION OF UNIT:		Ohm		
MENU 170	CHANGE		ESCAPE	REF.LENG

Use $\uparrow\downarrow$, ENTER to select.

This is where you select between "Ohm, Ohm/m, Ohm/km, Ohm/ft und Ohm/kft" as the units set in the display. This setting also affects the limit values.

With the display Ohm/m, Ohm/km, Ohm/ft or Ohm/kft based to the reference length at the right below corner the absolute resistance value appears.

Note: Make sure that the measuring ranges are always set in Ohm.

IMPORTANT: Important note if the reference length does not equal 1 m: The reference length is only taken into account and used for conversion in the instrument. If "Ohm/m, Ohm/km, Ohm/ft or Ohm/kft" has been selected as the units.

M 20 kOhm	Z1	SINGLE	A 100.0 C°	TC +3930	15
<h1>19.437 k $\frac{\Omega}{m}$</h1>					15.000 k Ω
					>
					10.000 k Ω
(-)	0 START		STOP		9.718 k Ω

absolute measurement value at measurement length 0.5 m

6.5.17 Measurement current selection

MEASUREMENT CURRENT				
LOW HIGH				
MENU 180	ENTER		ESCAPE	MEAS CURR

Depending upon environment of the measurement place strong electromagnetic fields can give a destabilise value in the display. To put things right it gives the possibility of the averaging of some measurement values or to increase the measurement current whereby you increase the signal -to-noise ratio. We recommend this setting at big transformers or big motors. At small coils (small cross sections) please check how far it gives a self heating concerning the increased current. The default setting (ex works) is the low current.

According the delivered model one of the following chart is valid:

Range	Resolution	Measurement current low	Measurement current high
*2 m Ω	0,0001 m Ω	3 A	3 A
20 m Ω	0,001 m Ω	1 A	1 A
200 m Ω	0,01 m Ω	100 mA	1 A
2 Ω	0,0001 Ω	10 mA	1 A
20 Ω	0,001 Ω	10 mA	100 mA
200 Ω	0,01 Ω	1 mA	10 mA
2 k Ω	0,1 Ω	1 mA	1 mA
20 k Ω	1 Ω	100 μ A	100 μ A
200 k Ω	10 Ω	100 μ A	10 μ A

*only RESISTOMAT® model 2316-V001

6.5.18 Calibration

The instrument is calibrated digitally. PC software model 2316-P001 and a range of series 1240 calibration resistances are required for this calibration.

7 Controlling the instrument remotely

7.1 Controlling the instrument via the PLC interface

Digital I/O

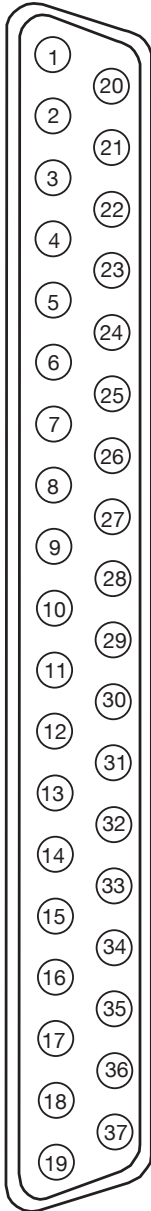

37-pin min sub-D
View towards socket

Pin	Function	Function
1	Relay	<, NO contact
2	NC	Not used
3	Relay	=, NO contact
4	PLC output	Device program saved ok
5	Relay	>, NO contact
6	Relay	Relay common contact
7	PLC output	Busy
8	PLC output	End of measurement
9	PLC output	Measuring error
10	PLC output	< K2
11	PLC output	Device program 0 mirrored
12	PLC output	= K1
13	PLC output	Device program 1 mirrored
14	PLC output	> K0
15	PLC output	DANGER
16	PLC output	Device program 2 mirrored
17	PLC output	Device program 3 mirrored
18	PLC	+ 24 V External
19	PLC	+ 24 V External
20	PLC	Ground 24 V External
21	PLC input	START / STOP measurement
22	PLC input	Comparator ON / OFF
23	PLC input	Remove load (cooling curve)
24	PLC input	Spare 1
25	PLC input	START printer
26	PLC input	Save device program
27	PLC input	Spare 2
28	PLC input	Device program 0
29	PLC input	Device program 1
30	PLC input	Device program 2
31	PLC input	Device program 3
32	PLC input	Spare 3
33	NC	Not used
34	Pyrometer	+ 10 V Analog input
35	Pyrometer	Ground, FE
36	Foot switch	NO contact
37	Foot switch	NO contact, DGND
Shell	Shield	Protective ground, PE

Connector shell: PE potential
Mating connector: Model 9900-V165

PLC input (circuit diagram)

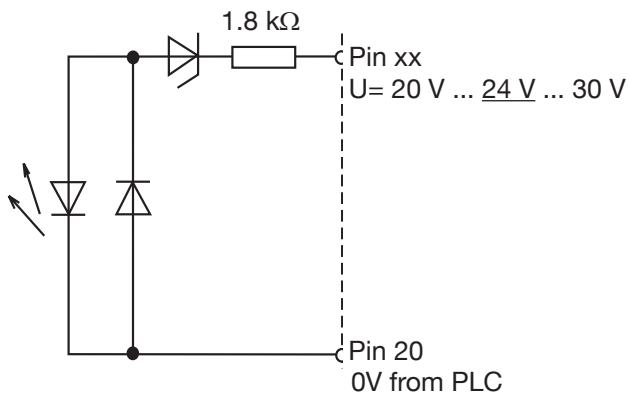

PLC output (circuit diagram)

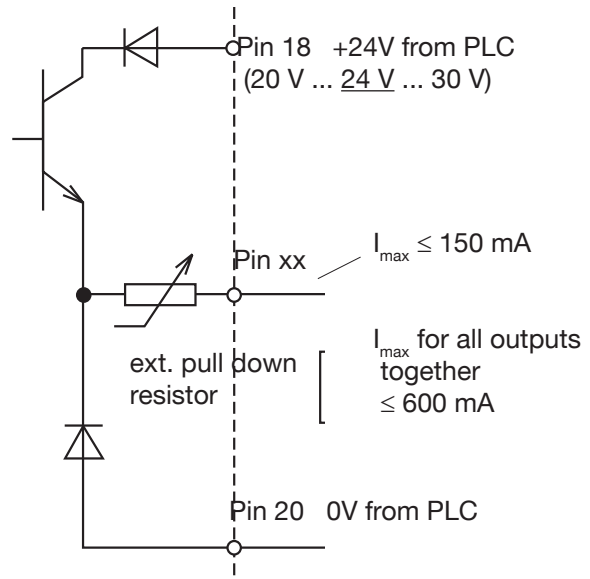

DC voltage supply:
 Grounding:
 PLC inputs Low:
 PLC inputs High:
 PLC - Input current:
 Outputs for current sinking inputs:

external 20 V ... 24 V ... 30 V
 external
 0 V ... + 5 V
 + 15 V ... + 30 V
 (Ue -8.4 V) / 1.8 k Ohm
 leakage current Low < 0.2 mA,
 total of all I_a < 0.6 A, I_a max.: 0.15 A

7.2 Controlling the instrument via the RS232 interface

7.2.1 Connector pin-out for the RS232 interface

The 9-pin min sub-D female connector is wired as follows:

For RS 232:

RESISTOMAT® Model 2316	Computer 9-pin	Computer 25-pin
Pin 2 TXD	Pin 2 RXD	Pin 3 RXD
Pin 3 RXD	Pin 3 TXD	Pin 2 TXD
Pin 8 -	Pin 8 CTS	Pin 5 CTS
Pin 7 - connected in meter	Pin 7 RTS	Pin 4 RTS
Pin 4 -	Pin 4 DTR	Pin 20 DTR
Pin 6 -	Pin 6 DSR	Pin 6 DSR
Pin 5 GND	Pin 5 GND	Pin 7 GND

Note: For Basic programs, DTR, DSR and CTS must be connected together at the PC end. This is not necessary if the 9-pin 1:1 cable model 9900-K333 is used, because these pins are connected in the instrument.

RESISTOMAT® Model 2316

7.2.2 Interface parameters

The interface parameters can be set in menu 150 Interface.

7.2.2.1 RS232

Baud rate: 300, 600, 1200, 2400, 4800, 9600(*), 19200, 38400, 56000, 57600
 Data bits: 7 or 8(*)
 Stop bits: 1(*) or 2
 Parity: none(*), even, odd
 Block check: enabled(*) - or disabled
 no hardware handshake

7.2.2.2 USB

Baudrate: 57600 (fixed)
 Datenbits: 8 (fixed)
 Stopbits: 1 (fixed)
 Parität: none (fixed)
 Blockcheck: enabled(*) - or disabled

7.2.2.3 Ethernet

DHCP: OFF(*) or ON
 IP-Adresse: 192.168.110.110 (*)
 Subnet: 255.255.255.000 (*)
 Gateway: 192.168.110.254
 Port: 5555 (*)
 MAC-Adresse: 00:30:f9:12:88:o5 (fixed)

7.2.2.4 Printer

Same settings as for the RS232 interface.

The printer can only be connected via the RS232 interface.

(*) → Default setting after initialization

7.2.3 Communications protocol

Control characters:	<STX> 0x02	=> Start of Text
	<ETX> 0x03	=> End of Text
	<ENQ> 0x05	=> Enquiry
	<ACK> 0x06	=> Acknowledge
	<S> 0x20	=> Space
	<NAK> 0x15	=> Not Acknowledge
	<CR> 0x0D	=> Carriage Return
	<LF> 0x0A	=> Line Feed
	<EOT> 0x04	=> End Of Transmission
	<NUL> 0x00	=> NULL character

Example:

The instrument waits for a command in the form: <STX>command<LF><ETX>

<STX>:	ASCII value 02
command1:	SCPI command without query form
<LF>:	ASCII value 10
<ETX>:	ASCII value 03

The ANSI standard X3.28-1976 Subcategory 2.5, A4 is used as the communications protocol. This standard is used in systems in which a number of secondary stations exist in a non switched multipoint connection, and all commands are sent by a control station. Only one transmitter (master) and one receiver (slave) are ever active on the bus at one time. One station is the control station. The control station is given master status and sends commands to a selected slave station, or relinquishes its master status to a secondary station and assumes slave status to receive data. A connection between two secondary stations is not allowed. The control station monitors the connection continuously.

7.2.4 Establishing a connection

Before a connection is established, the control station has master status and none of the secondary stations have slave status. The connection can be established in two different ways:

(1) "selection with response"

In this case, addressing the device does not take place in the same communications step as sending the command. This method is useful when you want to send several commands to the same device and then retrieve the responses to these commands at one go. (See communications example in section 8.16)

or

(2) "fast selection"

In this case addressing is combined with the command. This saves a communications step if you want to exchange data with several devices (via RS485) (see communications example in section 8.16)

When establishing a connection, the control station can either

- (1) specify a slave station
in order to set up a connection i.e. send a command to the addressed slave

or

- (2) poll,
in order to relinquish its master status to a secondary station i.e. query for a response to a previously sent command and hence assign the transmit right to the slave.

7.2.5 Selection with response

The control station sends a “selection supervisory sequence”. The selection supervisory sequence is used to initialize the 2316 as slave so that it is then possible to send it commands. The prefix calls up a single secondary station. **<ENQ>** defines the end of the selection supervisory sequence.

The selection supervisory sequence of the 2316 has the following format

<group_address><user_address>sr<ENQ>

- **< group_address >** Group address (decimal, 0 to 99)
- **< user_Address >** User address (decimal, 0 to 99)
- **sr** ASCII characters „s“ and „r“
- **<ENQ>** ASCII character ENQ

A secondary station that recognizes its selection supervisory sequence assumes slave status and sends one of two responses:

- (1) If the station is ready to receive data, it sends **<ACK>**. The master station starts the data transfer on receiving this response.
- (2) If the station is not ready to receive data, it sends **<NAK>**. With this response the master station tries to call up the same station again.

If the master station receives an invalid response or none at all, it can try to address the same station again or end the transmission.

7.2.6 Fast selection

Instead of „selection with response“, the master station can send a selection supervisory sequence without **<ENQ>**. The master station calls up a secondary station as the slave station. It then shifts directly into data transfer without waiting for the acknowledge response from the secondary station.

The fast selection supervisory sequence of the 2316 has the following format

<group_address><user_address>sr<STX>command<ETX><BCC>

- **< group_address >** Group address (decimal, 0 to 99)
- **< user_Address >** User address (decimal, 0 to 99)
- **sr** ASCII characters „s“ and „r“
- **<STX>** ASCII character STX
- **command** Command sequence
- **<ETX>** ASCII character ETX
- **<BCC>** Optional Block check

7.2.7 Polling

The control station sends a “polling supervisory sequence”. The polling supervisory sequence is used to retrieve requested data from the 2316. The prefix selects a single station. **<ENQ>** defines the end of the “polling supervisory sequence”:

The polling supervisory sequence of the 2316 has the following format:

<group_address><user_address>po<ENQ>

- **< group_address >** Group address (decimal, 0 to 99)
- **< user_Address >** User address (decimal, 0 to 99)
- **po** ASCII characters „p“ and „o“
- **<ENQ>** ASCII character ENQ

A secondary station that recognizes its polling supervisory sequence responds using one of two options:

- (1) If the station has data ready to send, it starts the data transfer. The control station assumes slave status.
- (2) If the station has no data ready to send, it sends **<EOT>**, which terminates its master status. The master status returns to the control station.

If the control station receives an invalid response or none at all, it terminates the connection by sending **<EOT>**.

7.2.8 Data transfer

After establishing the connection, the data is transferred in accordance with the rules of sub-category A4. The master station begins the transmission with **<STX>**, then sends the relevant data, and terminates the data block with **<ETX>**. The **<ETX>** character is followed by the optional block check character **<BCC>**. This is formed from all the bytes that come after **<STX>**, **including <ETX>**. The **<BCC>** is obtained by performing an exclusive-OR operation on all these bytes. 80hex is also OR'ed with the result of this operation in order to exclude any possible mix up with control characters.

The slave station sends one of two possible responses after detecting the **<BCC>**:

- If the data has been accepted and the station is ready to receive new data, it sends **<ACK>**. On receiving this, the master station either sends new data or terminates the data transfer.
- If the data was not accepted and the slave station is ready to receive new data, it sends **<NAK>**. On receiving this, the master station may send other data or terminate the connection.

7.2.9 Terminating a connection

The master station sends **<EOT>** to indicate that it has no more data to transfer. **<EOT>** returns the master status to the control station.

7.2.10 Examples of the communication sequence

The following sequence illustrates the 2316 communicating with a host controller in the two communications modes “selection with response” and “fast selection”. In the example, the *idn? query command is made, the 2316 has group address 00 and user address 00, and block check is disabled (in one example the block check is also shown for the given command / the given data).

7.2.10.1 Communication using „selection with response“

Controller sends: <EOT>

to make sure that all possible existing connections are terminated and the 2316 receive memory is cleared.

Controller sends: 0000sr<ENQ>

Selection: controller wishes to address the 2316 with group address 0 and user address 0

2316 replies with: <ACK>

The 2316 signals that it accepts the addressing

Controller sends, with block check OFF: <STX>*idn?<LF><ETX>

Command sequence: the idn? command is to be executed

2316 replies with: <ACK>

*The 2316 signals that it recognizes and has understood the *idn? command*

Controller sends: <EOT>

The host controller unaddresses the device in order to start a polling sequence immediately.

Controller sends: 0000po<ENQ>

The 2316 with group address 0 and user address 0 is required to send all responses waiting to be sent

2316 sends response, with block check OFF:

<STX>RESISTOMAT 2316,3A,0123456789,V200401,09.12.2004,1<CR><LF><ETX>

for type 2316-V0001

or 1A for type 2316-V0000

*This is the correct response to the *idn? command*

Controller sends: <ACK>

The controller has received the response and accepted it. Does the 2316 have other queries saved for which a response can now be sent?

2316 replies with: <EOT>

No. This ends the communication sequence and the 2316 has unaddressed itself automatically.

7.2.10.2 Communication using „fast selection“

Controller sends: <EOT>

to make sure that all possible existing connections are terminated and the 2316 receive memory is cleared.

Controller sends: 0000sr<STX>*idn?<LF><ETX>

Command sequence: controller wishes to address the 2316 with group address 0 and user address 0, and then make the 2316 execute the idn? command

2316 replies with: <ACK>

*The 2316 signals that it accepts the addressing and recognizes and has understood the *idn? command*

Controller sends: <EOT>

The host controller unaddresses the device in order to start a polling sequence immediately.

Controller sends: 0000po<ENQ>

The 2316 with group address 0 and user address 0 is required to send all responses waiting to be sent

2316 replies with: <STX>RESISTOMAT2316,3A,0123456789,
V200401,09.12.2004,1<CR><LF><ETX>

*This is the correct response to the *idn? command*

Controller sends: <ACK>

The controller has received the response and accepted it. Does the 2316 have other queries saved for which a response can now be sent?

2316 replies with: <EOT>

No. This ends the communication sequence and the 2316 has unaddressed itself automatically.

7.3 Controlling the instrument via Ethernet interface

The Ethernet RJ45 port is on the rear side of the device. Please use a Cat 5e or higher patch cable to connect the device to your Ethernet network. The relevant Ethernet parameters like IP address and port number can be found in the device menu 155 Ethernet Setup.

(for further information please see chapter „6.5.14.3 Ethernet Interface“ auf Seite 50).

7.3.1 The TCP transmission protocol

Communication with the RESISTOMAT® Model 2316 is based on TCP (Transmission Control Protocol). TCP is a connectionless communications protocol used on IP networks

Datagram format–Request to device

<EOT>0000sr<STX>Command<LF><ETX><CR>

Parameter	Value	Meaning
<STX>	0x02	Start of Text
<ETX>	0x03	End of Text
<EOT>	0x04	End Of Transmission
<ENQ>	0x05	Enquiry
<ACK>	0x06	Acknowledge
<LF>	0x0A	Line Feed
<NAK>	0x15	Not Acknowledge
<CR>	0x0D	Carriage Return

7.3.2 Programming example for “fast selection”

Ask for device model and identification:

1. PC: <EOT>0000sr<STX>*idn?<LF><ETX><CR>
2. 2316: <ACK><CR>
3. PC: <EOT>0000po<ENQ><CR>
4. 2316: <STX>RESISTOMAT2316,[device version],
[serial number],[software version]<CR><LF><ETX><CR><EOT><CR>

Measuring start:

5. PC: <EOT>0000sr<STX>init<LF><ETX><CR>
6. 2616: <ACK><CR>

Check and wait till a measuring value is available. Read SCPI status operation condition register and mask out Bit 8 (EOC) → if EOC=1 than a new meas. Value is available and the value you can read with the following command **fetc?**

7. PC: <EOT>0000sr<STX>S:O:C?<LF><ETX><CR>
8. 2316: <ACK><CR>
9. PC: <EOT>0000po<ENQ><CR>
10. 2316: <STX>[register value]<CR><LF><ETX><EOT><CR>

Read measuring value in PC:

11. PC: <EOT>0000sr<STX>fetc?<LF><ETX><CR>
12. 2316: <ACK><CR>
13. PC: <EOT>0000po<ENQ><CR>
14. 2316: <STX>[meas. value]<CR><LF><ETX><EOT><CR>

For a new measuring value go to line 7.
For the end go to line 15.

Measuring stop:

15. PC: <EOT>0000sr<STX>abor<LF><ETX><CR>
16. 2316: <ACK><CR>

7.3.3 Programming example for „selection with response“

Ask for device model and identification:

1. PC: <EOT>0000sr<ENQ><CR>
2. 2316: <ACK><CR>
3. PC: <STX>*idn?<LF><ETX><CR>
4. 2316: <ACK><CR>
5. PC: <EOT>0000po<ENQ><CR>
6. 2316: <STX>RESISTOMAT2316, [device version],
[serial number],[software version]<CR><LF><ETX><EOT><CR>

With EOT the communication sequence ends and the 2316 has unaddressed itself automatically.

Measuring start:

7. PC: <EOT>0000sr<ENQ><CR>
8. 2316: <ACK><CR>
9. PC: <STX>init<LF><ETX><CR>
10. 2316: <ACK><CR>

Check and wait till a measuring value is available. Read SCPI status operation condition register and mask out Bit 8 (EOC) → if EOC=1 than a new meas. Value is available and the value you can read with the following command **fetc?**

12. PC: <STX>S:O:C?<LF><ETX><CR>
13. 2316: <ACK><CR>
14. PC: <EOT>0000po<ENQ><CR>
15. 2316: <STX>[register value]<CR><LF><ETX><EOT><CR>

8 SCPI commands

8.1 General information

- Command sections contained in [] are optional.
- Commands have a long form and short form. Both forms are valid.
The short form is written in upper-case.
The long form is added in lower-case.
- The individual command levels are separated by a colon.
- There must be a space between the command and the first parameter.
- The individual parameters are separated by a comma.
- The individual responses are separated by a comma.
- The query form of a command is terminated with a question mark.
- The query form can also be sent at the same time as parameters.
In this case, the command is executed first and then the result (setting) returned.

8.1.1 Compatibility with 2318-V001

There is broad compatibility with old programs. The implemented SCPI command language has undergone significant development, however, and the device-timing of the RESISTOMAT® 2316 is completely different. Thus when using older software developed for the 2318 it may be necessary to remove wait cycles from some points and add wait cycles in others. In addition, a huge number of instrument functions have been added compared with the 2318 forerunner, although the dry-contact measurement is no longer included. This means that sometimes there is an “old” and a “new” command for one and the same function. The recommendation is not to use the “old” commands for new developments.

If you want to set maximum compatibility, please select compatibility mode 2318 on page 2 of Menu 150.

CONFIGURATION SERIAL INTERFACE ↑			
BLOCKCHECK: OFF			
COMPATIBILITY MODE: 2318			
MENU 150	CHANGE	ESCAPE	INTERFACE

Use $\uparrow\downarrow$ to move the selection bar, CHANGE to select. \uparrow shows that there is a first page:

Use the $\uparrow\downarrow$ buttons to toggle between the possible settings, and ENTER to adopt the setting shown.

Compatibility mode „2318“ means that the old interface commands for the RESISTOMAT® 2318 are recognized by the unit. The RESISTOMAT® 2316 provides functions that were not included in the RESISTOMAT® 2318, however, and vice versa. Please only use the old commands when it cannot be avoided, and leave the instrument in the standard configuration as far as possible.

8.1.2 Functions that have changed

- Setting the group and user address via the interface has led to problems in the past on the RESISTOMAT® 2318 and is therefore no longer possible. The instrument responds with NAK.
- Owing to the variable timing from averaging, the MEASURE and READ commands cannot be used any more. The instrument responds with NAK.
- The dry contact measurement is no longer provided. The instrument responds with NAK.
- The *IDN? query returns a different identification string because this contains the device ID.

8.1.3 List of old commands

Command	Meaning in 2318	Meaning in 2316
MEASure[:SCALar:RESistance:DC]	Stop, start, retrieve measurement	Not implemented, instrument returns NAK
READ[:SCALar:RESistance:DC]?	Stop, start, retrieve measurement	Not implemented, instrument returns NAK
FETCh[:SCALar:RESistance:DC]	Retrieve measurement	Implemented
INITiate[:IMMEDIATE]	Start measurement	Implemented
ABORT	Stop measurement	Implemented
SENSe:RESistance:RANGE:AUTO	Automatic measuring range on/off	Implemented
SENSe:RESistance:RANGE:[UPPer]	Set measuring range	Implemented
SENSe:RESistance:RANG:STORE	Save measuring range	Ignored, instrument returns ACK
CALibration:ZERO[:AUTO]	Zero offset	Implemented
SENSe:CORRection:		
TCOMPensate:MEDIum	TC for material	Implemented
SENSe:RESistance:LOAD	Resistive/inductive DUT	Executed. COMPL → Z3 REAL → Z1 Z2 cannot be set
SOURce:VOLTage:LIMIT[:AMPLitude]	Dry contact measurement	Not implemented, instrument returns NAK
CALCulate:LIMit:LOWer	Lower comparator limit	Implemented
CALCulate:LIMit:UPPer	Upper comparator limit	Implemented
CALCulate:LIMit:STATe	Comparator on	Implemented
SYSTem:COMMunicate: SERial:ADDRess:GROup	Group address	Not implemented, instrument returns NAK
SYSTem:COMMunicate: SERial:ADDRess:USER	User address	Not implemented, instrument returns NAK
SYSTem:ERRor?	System error query	Implemented
TEST:DISPlay	7-segment test	Ignored, instrument returns ACK
SYSTem:KLOCK	Keypad locked	Ignored, instrument returns ACK
*IDN?	Identification string	Different response
*RST	Reset	Implemented
STATus:QUEStionable[:EVENT]?	Read Q. Event register	Implemented
STATus:QUEStionable:CONDition?	Read Q. Condition register	Implemented
STATus:QUEStionable:ENABle	Set/read Q. Enable register	Implemented
STATus:OPERation[:EVENT]?	Read O. Event register	Implemented
STATus:OPERation:CONDition?	Read O. Condition register	Implemented
STATus:OPERation:ENABle	Set/read O. Enable register	Implemented
STATus:PRESet	Reset SCPI Enable register	Implemented
*CLS	Reset Event register	Implemented
*ESR?	Read Standard Event reg.	Implemented
*ESE	set/read Standard Event Enable register	Implemented

8.2 SCPI registers

The bits labeled * are used.

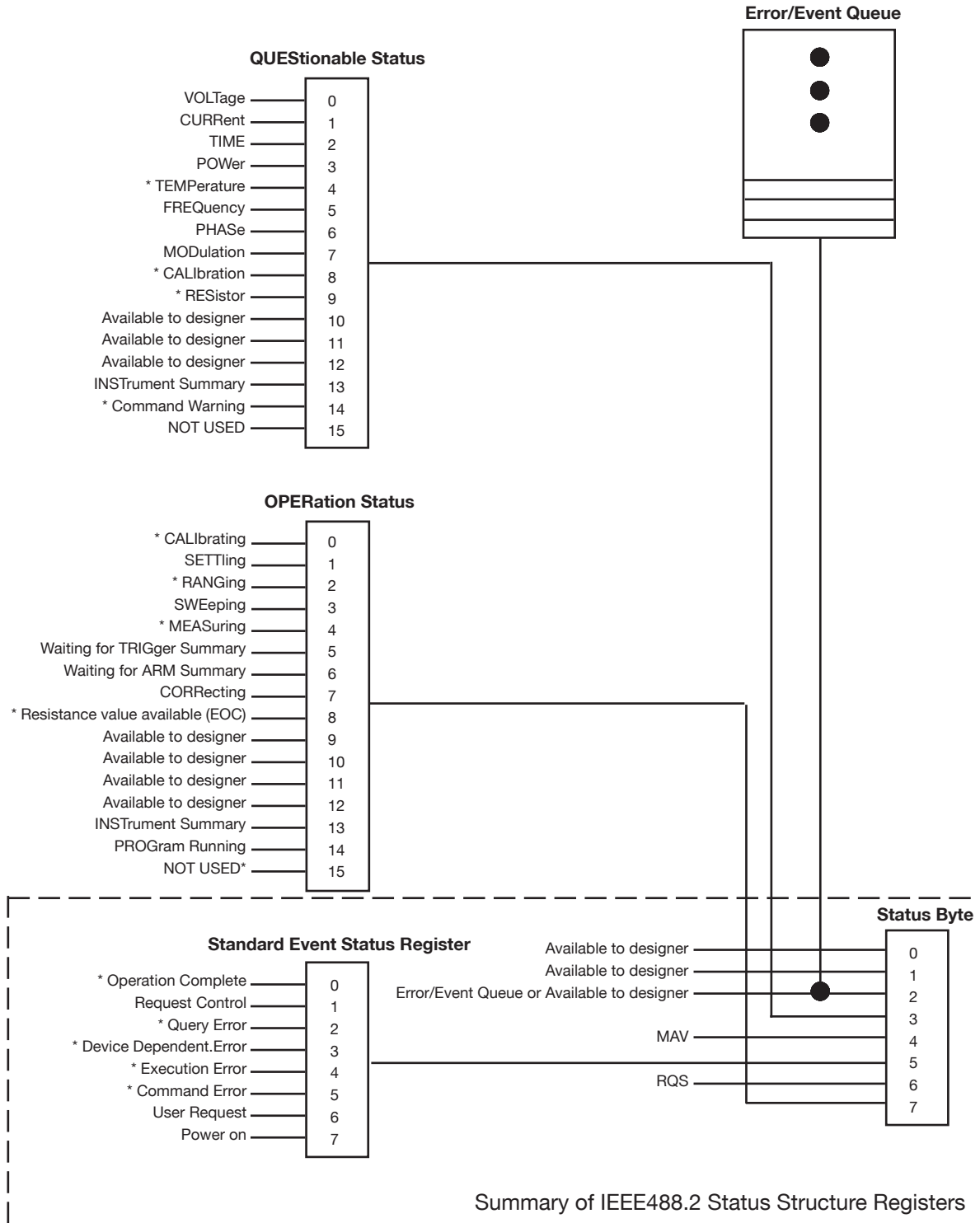

Note: In continuous measuring mode the registers are set as following:
 The most current measurement value is always written into the output buffer.
 In the Operation Status Register Bit 8 is set if a valid measurement value is present.
 In the Questionable Status Register Bit 9 is set if any error is present.
 With the Fetch instruction only one measured value should be fetched, if Bit 8 in the Operation Status Register is set.

8.3 ACCess Subsystem

8.3.1 ACCess:LEVel

DESCRIPTION: Sets the access levels.

SYNTAX: ACCess:LEVel P1

Meaning of parameter Pn

Parameter	Meaning	Value
P1	Permitted access	1 → Start and stop permitted 2 → Start, stop and measuring-range selection permitted 3 → Start, stop, measuring-range selection and comparator limits permitted 4 → Unrestricted access

QUERY FORM: ACCess:LEVel ?

RESPONSE: A1

Meaning of response An

Response	Meaning	Value
A1	Permitted access	1 → If start and stop permitted 2 → Start, stop and measuring-range selection permitted 3 → If start, stop, measuring-range selection and comparator limits permitted 4 → If unrestricted access

Note: Command not allowed in calibration mode.
Command not allowed when measurement running.

8.4 DISPlay Subsystem

8.4.1 DISPlay:CONTRast

DESCRIPTION: Can be used to adjust the LCD contrast.

SYNTAX: DISPlay:CONTRast P1

Meaning of parameter Pn

Parameter	Meaning	Value
P1	LCD contrast	Floating-point value between 0.0 and 1.0 0.0 → minimum contrast 1.0 → maximum contrast

QUERY FORM: DISPlay:CONTRast?

RESPONSE: A1

Meaning of response An

Response	Meaning	Value
A1	LCD contrast	Floating-point value between 0.0 and 1.0 0.0 → minimum contrast 1.0 → maximum contrast Value to one decimal place is transferred

Note: Command not allowed in calibration mode.
Command not allowed when measurement running.

8.5 CALCulate Subsystem

8.5.1 CALCulate:LIMit:STATe

DESCRIPTION: Enables or disables the comparator function.

SYNTAX: CALCulate:LIMit:STATe P1

Meaning of parameter Pn

Parameter	Meaning	Value
P1	Comparator on/off	1 or ON → Comparator function enabled 0 or OFF → Comparator function disabled

QUERY FORM: CALCulate:LIMit:STATe?

RESPONSE: A1

Meaning of response An

Response	Meaning	Value
A1	Comparator on/off	1 or ON → If comparator function enabled 0 or OFF → If comparator function disabled

Note: Command not allowed in calibration mode.
Command not allowed when measurement running.

8.5.2 CALCulate:LIMit:RELais

DESCRIPTION: Enables or disables the relay function.

SYNTAX: CALCulate:LIMit:RELais P1

Meaning of parameter Pn

Parameter	Meaning	Value
P1	Relay function	1 or ON → Relay function enabled
	on/off	0 or OFF → Relay function disabled

QUERY FORM: CALCulate:LIMit:RELais?

RESPONSE: A1

Meaning of response An

Response	Meaning	Value
A1	Relay function	1 or ON → If relay function enabled
	on/off	0 or OFF → If relay function disabled

Note: Command not allowed in calibration mode.
Command not allowed when measurement running.

8.5.3 CALCulate:LIMit:RESet

DESCRIPTION: Behavior of comparator function. The comparator is reset with Start measurement (static behavior) or not reset (dynamic behavior).

SYNTAX: CALCulate:LIMit:RESet P1

Meaning of parameter Pn

Parameter	Meaning	Value
P1	Behavior of comparator	1 or ON → Comparator is reset with Start measurement (static behavior) 0 or OFF → Comparator is not reset with Start measurement (dynamic behavior)

QUERY FORM: CALCulate:LIMit:RESet?

RESPONSE: A1

Meaning of response An

Response	Meaning	Value
A1	Behavior of comparator	1 → Comparator is reset with Start measurement (static behavior) 0 → Comparator is not reset with Start measurement (dynamic behavior)

Note: Command not allowed in calibration mode.
Command not allowed when measurement running

8.5.4 CALCulate:LIMit:LOWer

DESCRIPTION: Sets the lower comparator limit. This value is not adopted, however, until the CALCulate:LIMit:ACKnowledge? command is received, once the upper comparator limit has also been transferred using the CALCulate:LIMit:UPPer command.

SYNTAX: CALCulate:LIMit:LOWer P1

Meaning of parameter Pn

Parameter	Meaning	Value
P1	Lower camparator limit	Numerical value, optionally with units (UOHM, MOHM, OHM,KOHM) If no units are sent, then the value is interpreted as OHM

QUERY FORM: CALCulate:LIMit:LOWer?

RESPONSE: A1

Meaning of response An

Response	Meaning	Value
A1	Present lower comparator limit	Numerical value with units of OHM

Note: Command not allowed in calibration mode.
Command not allowed when measurement running.

8.5.5 CALCulate:LIMit:UPPer

DESCRIPTION: Sets the upper comparator limit. This value is not adopted, however, until the CALCulate:LIMit: ACKNowledge? command is received, once the lower comparator limit has also been transferred using the CALCulate:LIMit:LOWer command.

SYNTAX: CALCulate:LIMit:UPPer P1

Meaning of parameter Pn

Parameter	Meaning	Value
P1	Upper comparator limit	Numerical value, optionally with units (UOHM, MOHM, OHM,KOHM) If no units are sent, then the value is interpreted as OHM

QUERY FORM: CALCulate:LIMit:UPPer?

RESPONSE: A1

Meaning of response An

Response	Meaning	Value
A1	Present upper comparator limit	Numerical value with units of OHM

Note: Command not allowed in calibration mode.
Command not allowed when measurement running.

8.5.6 CALCulate:LIMit:ACKnowledge?

DESCRIPTION: Adopts the comparator limits. This command causes those comparator limits to be adopted that were previously transferred using the two commands CALCulate:LIMit:LOWer (lower comparator limit) and CALCulate:LIMit:UPPer (upper comparator limit).

SYNTAX: CALCulate:LIMit:ACKnowledge?

No parameter

QUERY FORM: Query form only

RESPONSE: A1

Meaning of response An

Response	Meaning	Value
A1	Status of adoption of comparator limits	1→ Limits have been adopted; all ok 0→ Limits have not been adopted

Note: Command not allowed in calibration mode.
Command not allowed when measurement running.

8.5.7 CALCulate:LIMit:CONTRol:DATA

DESCRIPTION: Sets the number of measurements after Start before evaluation made.

SYNTAX: CALCulate:LIMit:CONTRol:DATA P1

Meaning of parameter Pn

Parameter	Meaning	Value
P1	The number measurements after Start before evaluation	Integer between 1 and 999

QUERY FORM: CALCulate:LIMit:CONTRol:DATA?

RESPONSE: A1

Meaning of response An

Response	Meaning	Value
A1	The number measurements after Start before evaluation	Integer between 1 and 999

Note: Command not allowed in calibration mode.
Command not allowed when measurement running.

8.5.8 CALCulate:MATH[:EXPRession]

DESCRIPTION: Switches the measurement display between Ohm and Ohm/m

SYNTAX: CALCulate:MATH[:EXPRession] P1

Meaning of parameter Pn

Parameter	Meaning	Value
P1	Display in Ohm or Ohm/m	OHM → Measurement display in Ohm
		OHM/M → Measurement display in Ohm/m
		OHM/KM → Measurement display in Ohm/km
		OHM/FT → Measurement display in Ohm/ft
		OHM/KFT → Measurement display in Ohm/kft

QUERY FORM: CALCulate:MATH[:EXPRession]?

RESPONSE: A1

Meaning of response An

Response	Meaning	Value
A1	Display in Ohm or Ohm/m	OHM → Measurement display in Ohm
		OHM/M → Measurement display in Ohm/m
		OHM/KM → Measurement display in Ohm/km
		OHM/FT → Measurement display in Ohm/ft
		OHM/KFT → Measurement display in Ohm/kft

Note: Command not allowed in calibration mode.
Command not allowed when measurement running.

8.6 SCALE Subsystem

8.6.1 SCALE:VOLTage

DESCRIPTION: Scales the voltage input from the pyrometer.

SYNTAX: SCALE:VOLTage P1,P2,P3,P4

Meaning of parameter Pn

Parameter	Meaning	Value
P1	Lower voltage	Floating-pt value optionally with units (UV, MV, V, KV, MAV)
P2	Upper voltage	Floating-pt value optionally with units (UV, MV, V, KV, MAV)
P3	Lower temperature	Floating-point value optionally with units (C, CEL)
P4	Upper temperature	Floating-point value optionally with units (C, CEL)

Condition:

Lower voltage < Upper voltage and Lower temperature < Upper temperature

QUERY FORM: SCALE:VOLTage?

RESPONSE: A1,A2,A3,A4

Meaning of parameter An

Parameter	Meaning	Value
P1	Lower voltage	Floating-pt value with units V
P2	Upper voltage	Floating-pt value with units V
P3	Lower temperature	Floating-point value with units CEL
P4	Upper temperature	Floating-point value with units CEL

Note: Command not allowed in calibration mode.
Command not allowed when measurement running.

8.6.2 SCALE:PT100

DESCRIPTION: Sets the Pt100 coefficients for positive temperatures.

SYNTAX: SCALE:PT100 P1,P2,P3

Meaning of parameter Pn

Parameter	Meaning	Value
P1	Pt100 coefficient R0	Floating-point value
P2	Pt100 coefficient a	Floating-point value
P3	Pt100 coefficient b	Floating-point value

Equation: $R_t = R_0 * (1 + a * t + b * t^2)$

QUERY FORM: SCALE:PT100?

RESPONSE: A1,A2,A3

Meaning of parameter An

Response	Meaning	Value
A1	Pt100 coefficient R0	Floating-point value
A2	Pt100 coefficient a	Floating-point value
A3	Pt100 coefficient b	Floating-point value

Note: Command not allowed in calibration mode.
Command not allowed when measurement running.

8.7 HCOPy Subsystem

8.7.1 HCOPy:DESTination

DESCRIPTION: Sets the function of the serial port.
 Printer output or PC interface.

SYNTAX: HCOPy:DESTination P1

Meaning of parameter Pn

Parameter	Meaning	Value
P1	Function of the serial port	PRINTER → Serial port is the printer output

QUERY FORM: HCOPy:DESTination?

RESPONSE: A1

Meaning of response An

Response	Meaning	Value
A1	Function of the serial port	PRINTER → Serial port is the printer output

Note: Command not allowed in calibration mode.
 Command not allowed when measurement running.

8.8 CCURve Subsystem

8.8.1 CCURve:TIME:END

DESCRIPTION: Sets the time length of the full cooling curve measurement (end time).

SYNTAX: CCURve:TIME:END P1

Meaning of parameter Pn

Parameter	Meaning	Value
P1	End time	Integer between 1 and 9999 in seconds

QUERY FORM: CCURve:TIME:END?

RESPONSE: A1

Meaning of response An

Response	Meaning	Value
A1	End time	Integer between 1 and 9999 in seconds

Integer between 1 and 9999 in seconds

Note: Command not allowed in calibration mode.
Command not allowed when measurement running.

8.8.2 CCURve:TIME:DELTA

DESCRIPTION: Sets the time interval between measurements (delta time) on the cooling curve.

SYNTAX: CCURve:TIME:DELTA P1

Meaning of parameter Pn

Parameter	Meaning	Value
P1	Time interval between measurements on cooling curve	Integer between 1 and 9999 in seconds

QUERY FORM: CCURve:TIME:DELTA?

RESPONSE: A1

Meaning of response An

Response	Meaning	Value
A1	Time interval between measurements on cooling curve	Integer between 1 and 9999 in seconds

Note: Command not allowed in calibration mode.
Command not allowed when measurement running

8.8.3 CCURve:COUNT

DESCRIPTION: Returns the number of measurements saved in the data logger

SYNTAX: CCURve:COUNT?

No parameter

QUERY FORM: Query form only

RESPONSE: A1

Meaning of response An

Response	Meaning	Value
A1	Number of measurements in the data logger	Numerical value

Note: Command not allowed in calibration mode.
Command not allowed when measurement running.

8.8.4 CCURve:DATA

DESCRIPTION: Can be used to read the individual entries in the data logger.

SYNTAX: CCURve:DATA? P1

Meaning of parameter Pn

Parameter	Meaning	Value
P1	Entry number in the data logger	Numerical value

QUERY FORM: Query form only

RESPONSE: A1,A2,A3,A4

Meaning of response An

Response	Meaning	Value
A1	Entry number	Numerical value
A2	Time in seconds relative to when load removed	Floating-point value with units (s)
A3	Resistance value	Floating-point value with units
A4	Identification of start/stop cycles	Consecutive letters of the alphabet

Note: Command not allowed in calibration mode.
Command not allowed when measurement running.

8.8.5 CCURve:CHARge

DESCRIPTION: START / STOP time from load removal.

SYNTAX: CCURve:CHARge P1

Meaning of parameter Pn

Parameter	Meaning	Value
P1	Start / stop time from load removal	1 or ON → start time after load removal 0 or OFF → stop time again

QUERY FORM: No query form

Note: Command not allowed in calibration mode.
Command not allowed when measurement running.
Command only allowed in cooling-curve mode.

8.8.6 CCURve:INITiate

DESCRIPTION: Starts the cooling-curve measurement.

SYNTAX: CCURve:INITiate

No parameter

QUERY FORM: No query form

Note: Command not allowed in calibration mode.
Command not allowed when measurement running.
Command only allowed in cooling-curve mode.

8.8.7 CCURve:ABORT

DESCRIPTION: Stops the cooling-curve measurement.

SYNTAX: CCURve:ABORT

No parameter

QUERY FORM: No query form

Note: Command not allowed in calibration mode.
Command not allowed when measurement running.
Command only allowed in cooling-curve mode.

8.9 TRACe Subsystem

8.9.1 TRACe:DATA:LENGth

DESCRIPTION: Transfers and queries the reference length.

SYNTAX: TRACe:DATA:LENGth P1

Meaning of parameter Pn

Parameter	Meaning	Value
P1	Reference length	Floating-pt value optionally with units (UM, MM, CM, DM, M, KM)

QUERY FORM: TRACe:DATA:LENGth?

RESPONSE: A1

Meaning of response An

Response	Meaning	Value
A1	Reference length	Floating-point value with units M

Note: Command not allowed in calibration mode.
Command not allowed when measurement running.

8.10 TRIGger Subsystem

8.10.1 ABORT

DESCRIPTION: Stops a measurement that has been started.

SYNTAX: ABORT

No parameter

QUERY FORM: No query form

Note: Command not allowed in calibration mode.
Command not allowed if measurement already stopped.

For speed reasons there is also a non-SCPI-compliant short form: AB

8.10.2 INITiate[IMMediate]

DESCRIPTION: Starts a measurement that has been stopped.

SYNTAX: INITiate[IMMediate]

No parameter

QUERY FORM: No query form

Note: Command not allowed in calibration mode.
Command not allowed when measurement already started.

For speed reasons there is also a non-SCPI-compliant short form: IN

8.10.3 INITiate:CONTInuous

DESCRIPTION: Switches between single and continuous measurement mode.

SYNTAX: INITiate:CONTInuous P1

Meaning of parameter Pn

Parameter	Meaning	Value
P1	Single or continuous measurement	1 or ON → continuous measurement
		0 or OFF → single shot

QUERY FORM: INITiate:CONTInuous?

RESPONSE: A1

Meaning of response An

Response	Meaning	Value
A1	Single or continuous measurement	1 → continuous measurement
		0 → single shot

Note: Command not allowed in calibration mode.
Command not allowed when measurement running.

RESISTOMAT® Model 2316

8.10.4 FETCh?

DESCRIPTION: Can be used to retrieve one measurement.

SYNTAX: FETCh?

No parameter

QUERY FORM: Query form only

RESPONSE: A1, A2

Meaning of response An

Response	Meaning	Value
A1	Measured resistance value	Floating-point value with units
A2	Comparator result, if comparator enabled	<, = or >

Note: Command not allowed in calibration mode.

For speed reasons there is also a non-SCPI-compliant short form: FE

8.11 SYSTEM subsystem

8.11.1 SYSTEM:VERSion?

DESCRIPTION: Returns the SCPI version.

SYNTAX: SYSTEM:VERSion?

No parameter

QUERY FORM: Query form only

RESPONSE: A1

Meaning of response An

Response	Meaning	Value
A1	The SCPI version	1997.0

8.11.2 SYSTem:LANGUage

DESCRIPTION: Sets and queries the operating language.

SYNTAX: SYSTem:LANGUage P1

Meaning of parameter Pn

Parameter	Meaning	Value
P1	Operating language	GERMAN → German operating language ENGLISH → English operating language FRENCH → French operating language ITALIAN → Italian operating language SPANISH → Spanish operating language

QUERY FORM: SYSTem:LANGUage?

RESPONSE: A1

Meaning of response An

Response	Meaning	Value
A1	Operating language	GERMAN → German operating language ENGLISH → English operating language FRENCH → French operating language ITALIAN → Italian operating language SPANISH → Spanish operating language

Note: Command not allowed in calibration mode.
Command not allowed when a measurement is running.

8.11.3 SYSTem:PASSword

DESCRIPTION: Can be used to set and query the reset password and access password.

SYNTAX: SYSTem:PASSword P1, P2

Meaning of parameter Pn

Parameter	Meaning	Value
P1	The access password	Numerical value between 0000 and 9999
P2	The reset password	Numerical value between 0000 and 9999

QUERY FORM: SYSTem:PASSword?

RESPONSE: A1, A2

Meaning of response An

Response	Meaning	Value
A1	The access password	Numerical value between 0000 and 9999
A2	The reset password	Numerical value between 0000 and 9999

8.11.4 SYSTem:ERRor[:NEXT]?

DESCRIPTION: Can be used to query any errors that may have occurred at the instrument.

SYNTAX: SYSTem:ERRor[:NEXT]?

No parameter

QUERY FORM: Query form only

RESPONSE: A1

Meaning of response An

	Response	Meaning	Value
A1	Error status	0, NO ERROR: -100, COMMAND ERROR: -101, INVALID CHARACTER: -105, GET NOT ALLOWED: -108, PARAMETER NOT ALLOWED: -109, MISSING PARAMETER: -110, COMMAND HEADER ERROR: -120, NUMERIC DATA ERROR: -200, EXECUTION ERROR: -204, ILLEGAL DEVICE STATE: -213, INIT IGNORED: -220, PARAMETER ERROR: -221, SETTING CONFLICT: -222, DATA OUT OF RANGE: -224, ILLEGAL PARAMETER VALUE: -231, DATA QUESTIONABLE: -350, QUEUE OVERFLOW: -400, QUERY ERROR: -410, QUERY INTERRUPTED: -420, QUERY UNTERMINATED: -720, RESISTANCE UNTERMINATED: OFFSET ERROR	No errors present. An invalid command was sent. A command contains an invalid character. GET command was sent within a command. Inadmissible parameter No parameter supplied. A command with an invalid command header. An invalid numerical value. The command could not be executed because of a particular device state. Command is valid, but cannot be executed in the current device state. The INITIALize command was ignored. Command with an invalid parameter. Because of the setting, a command with the given parameter cannot be executed. A parameter lies outside the valid limits. A valid parameter, but not one used by the device. The value of a parameter is questionable. Error-buffer overflow. A query was sent to the device without any data being available. The device was interrupted before it had sent a complete response. A full response was not sent. Taring is not possible due to the applied voltage being higher than 5 % of the measuring range.

8.12 STATUS Subsystem

8.12.1 STATUS:PRESet

DESCRIPTION: Resets both the Operation Status Enable register and the Questionable Status Enable register to 0.

SYNTAX: STATUS:PRESet

No parameter

QUERY FORM: No query form

8.12.2 STATUS:OPERation:ENABLE

DESCRIPTION: Sets the Operation Status Enable register.

SYNTAX: STATUS:OPERation:ENABLE P1

Meaning of parameter Pn

Parameter	Meaning	Value
P1	Contents of the 16-bit Operation Status Enable register	Decimal value between 0 and 32767

QUERY FORM: STATUS:OPERation:ENABLE?

RESPONSE: A1

Meaning of response An

Response	Meaning	Value
A1	Contents of the 16-bit Operation Status Enable register	Decimal value between 0 and 32767

8.12.3 STATus:QUEStionable:ENABle

DESCRIPTION: Sets the Questionable Status Enable register.

SYNTAX: STATus:QUEStionable:ENABle P1

Meaning of parameter Pn

Parameter	Meaning	Value
P1	Contents of the 16-bit Operation Status Enable register	Decimal value between 0 and 32767

QUERY FORM: STATus:QUEStionable:ENABle?

RESPONSE: A1

Meaning of response An

Response	Meaning	Value
A1	Contents of the 16-bit Operation Status Enable register	Decimal value between 0 and 32767

8.12.4 STATus:OPERation:CONDition?

DESCRIPTION: Reads the Operation Status Condition register.

SYNTAX: STATus:OPERation:CONDition?

No parameter

QUERY FORM: Query form only

RESPONSE: A1

Meaning of response An

Response	Meaning	Value
A1	Contents of the 16-bit Operation Status Condition register	Decimal value between 0 and 32767

For speed reasons there is also a non-SCPI-compliant short form: S:O:C?

8.12.5 STATus:QUEStionable:CONDition?

DESCRIPTION: Reads the Questionable Status Condition register.

SYNTAX: STATus:QUEStionable:CONDition?

No parameter

QUERY FORM: Query form only

RESPONSE: A1

Meaning of response An

Response	Meaning	Value
A1	Contents of the 16-bit Questionable Status Condition register	Decimal value between 0 and 32767

For speed reasons there is also a non-SCPI-compliant short form: S:Q:C?

8.12.6 STATus:OPERation[:EVENT]?

DESCRIPTION: Reads the Operation Status Event register.

SYNTAX: STATus:OPERation[:EVENT]?

No parameter

QUERY FORM: Query form only

RESPONSE: A1

Meaning of response An

Response	Meaning	Value
A1	Contents of the 16-bit Operation Status Event register	Decimal value between 0 and 32767

For speed reasons there is also a non-SCPI-compliant short form: S:Q:[E]?

8.12.7 STATus:QUEStionable:[EVENT]?

DESCRIPTION: Reads the Questionable Status Event register.

SYNTAX: STATus:QUEStionable:[EVENT]?

No parameter

QUERY FORM: Query form only

RESPONSE: A1

Meaning of response An

Response	Meaning	Value
A1	Contents of the 16-bit Questionable Status Event register	Decimal value between 0 and 32767

Note: Error remains stored effected to inquiry.

For speed reasons there is also a non-SCPI-compliant short form: S:Q:[E]?

8.13 SENSE Subsystem

8.13.1 SENSE:TCOMPensate

DESCRIPTION: Sets the type of temperature sensor for the temperature compensation is detected.

SYNTAX: SENSE:TCOMPensate P1

Meaning of parameter Pn

Parameter	Meaning	Value
P1	How the temperature is detected	MAN → Manual temperature input
		PT100 → Deteced using Pt100 (default coefficients)
		PT100INDIV → Detected using Pt100 (selectable coefficients)
		UINP → Detected using pyrometer (U-input)

QUERY FORM: SENSE:TCOMPensate?

RESPONSE: A1,A2,A3,A4

Meaning of response An

Response	Meaning	Value
A1	How the temperature is detected	MAN → Manual temperature input
		PT100 → Deteced using Pt100 (default coefficients)
		PT100INDIV → Detected using Pt100 (selectable coefficients)
		UINP → Detected using pyrometer (U-input)

Note: Command not allowed in calibration mode.
Command is not allowed when a measurement is running.

8.13.2 SENSE:TCOMpensate:STATE

DESCRIPTION: Enables or disables temperature compensation.

SYNTAX: SENSE:TCOMpensate:STATE P1

Meaning of parameter Pn

Parameter	Meaning	Value
P1	Temperature compensation on or off	1 or ON → Enable temperature compensation 0 or OFF → Disable temperature compensation

QUERY FORM: SENSE:TCOMpensate:STATE?

RESPONSE: A1

Meaning of response An

Response	Meaning	Value
A1	Temperature compensation on or off	1 → Enable temperature compensation 0 → Disable temperature compensation

Note: Command not allowed in calibration mode.
Command is not allowed when a measurement is running.

8.13.3 SENSE:TCOMpensate:TEMPerature

DESCRIPTION: Sets the temperature for manual temperature compensation.

SYNTAX: SENSE:TCOMpensate:TEMPerature P1

Meaning of parameter Pn

Parameter	Meaning	Value
P1	Temperature for manual temperature compensation	Floating-pt value optionally with units (C or CL)

QUERY FORM: SENSE:TCOMpensate:TEMPerature?

RESPONSE: A1

Meaning of response An

Response	Meaning	Value
A1	Temperature for manual and automatic temperature compensation	Floating-point value with units CEL

Note: Command not allowed in calibration mode.
Command is not allowed when a measurement is running.

8.13.4 SENSE:TCOMPensate:TEMPerature:REFerence

DESCRIPTION: Sets the reference temperature for temperature compensation.

SYNTAX: SENSE:TCOMPensate:TEMPeratureREFerence P1

Meaning of parameter Pn

Parameter	Meaning	Value
P1	Reference temperature for temperature compensation	Floating-pt value optionally with units (C or CEL)

QUERY FORM: SENSE:TCOMPensate:TEMPerature:REFerence?

RESPONSE: A1

Meaning of response An

Response	Meaning	Value
A1	Reference temperature for and automatic temperature compensation	Floating-point value with units CEL

Note: Command not allowed in calibration mode.
Command is not allowed when a measurement is running.

Note: The reference temperature specifies the temperature to which the measurement is corrected. In Europe this temperature is usually 20 °C, in USA 23°C or 25 °C. This temperature has nothing to do with the measured room temperature.

8.13.5 SENSE:TCOMpensate:TCOefficient:SElect

DESCRIPTION: Selects a temperature coefficient for the temperature compensation.

SYNTAX: SENSE:TCOMpensate:TCOefficient:SElect P1

Meaning of parameter Pn

Parameter	Meaning	Value
P1	Number of the temperature coefficient	Numerical value between 1 and 16 1 → TEMPCOMP_OFF 2 → TEMPCOMP_COPPER 3 → TEMPCOMP_ALU 4 → TEMPCOMP_BRASS63 5 → TEMPCOMP_BRASS80 6 → TEMPCOMP_TUNGSTEN 7 → TEMPCOMP_NICKEL 8 → TEMPCOMP_PLATIN 9 → TEMPCOMP_USER 1 10 → TEMPCOMP_USER 2 11 → TEMPCOMP_USER 3 12 → TEMPCOMP_USER 4 13 → TEMPCOMP_USER 5 14 → TEMPCOMP_USER 6 15 → TEMPCOMP_USER 7 16 → TEMPCOMP_USER 8

QUERY FORM: SENSE:TCOMpensate:TCOefficient:SElect?

RESPONSE: A1

Meaning of response An

Response	Meaning	Value
A1	Number of the temperature coefficient	Numerical value between 1 and 16 1 → TEMPCOMP_OFF 2 → TEMPCOMP_COPPER 3 → TEMPCOMP_ALU 4 → TEMPCOMP_BRASS63 5 → TEMPCOMP_BRASS80 6 → TEMPCOMP_TUNGSTEN 7 → TEMPCOMP_NICKEL 8 → TEMPCOMP_PLATIN 9 → TEMPCOMP_USER 1 10 → TEMPCOMP_USER 2 11 → TEMPCOMP_USER 3 12 → TEMPCOMP_USER 4 13 → TEMPCOMP_USER 5 14 → TEMPCOMP_USER 6 15 → TEMPCOMP_USER 7 16 → TEMPCOMP_USER 8

Note: Command not allowed in calibration mode.
 Command is not allowed when a measurement is running.

8.13.6 SENSE:TCOMpensate:TCOefficient:USER:CHANge

DESCRIPTION: Can be used to set the user-definable temperature coefficients.

SYNTAX: SENSE:TCOMpensate:TCOefficient:USER:CHANge P1, P2, P3

Meaning of parameter Pn

Parameter	Meaning	Value
P1	Number of the user-definable TC	Numerical value between 9 and 16
P2	TC identifier	String with up to 10 characters
P3	Value of the TC in ppm	Floating-point value

QUERY FORM: SENSE:TCOMpensate:TCOefficient:USER:CHANge? P1

RESPONSE: A1,A2,A3

Meaning of parameter Pn

Parameter	Meaning	Value
P1	Number of the user-definable TC	Numerical value between 9 and 16

Meaning of response An

Response	Meaning	Value
A1	Number of the user-definable TC	Numerical value between 9 and 16
A2	TC identifier	String with up to 10 characters
A3	Value of the TC in ppm	Floating-point value

Note: Command not allowed in calibration mode.
Command is not allowed when a measurement is running.

8.13.7 SENSE:FRESistance:RESolution

DESCRIPTION: Sets the resolution of the measurement display.

SYNTAX: SENSE:FRESistance:RESolution P1

Meaning of parameter Pn

Parameter	Meaning	Value
P1	Resolution of the measurement display	0.0005 → Low resolution (2000)
		0.00005 → High resolution (20000)

QUERY FORM: SENSE:FRESistance:RESolution?

RESPONSE: A1

Meaning of response An

Response	Meaning	Value
A1	Resolution of the measurement display	0.0005 → Low resolution (2000)
		0.00005 → High resolution (20000)

Note: Command not allowed in calibration mode.
 Command is not allowed when a measurement is running.
 RESistance can also be used instead of FRESistance.

8.13.8 SENSE:FRESistance:MODE

DESCRIPTION: Selects the measurement mode.

SYNTAX: SENSE:FRESistance:MODE P1

Meaning of parameter Pn

Parameter	Meaning	Value
P1	Measurement mode	SINGle → Single shot CONTInuous → Continuous measurement ALTeRNate → Alternating measurement CCURve → Cooling curve FASTmeasure → Fast measurement

QUERY FORM: SENSE:FRESistance:MODE?

RESPONSE: A1

Meaning of response An

Response	Meaning	Value
A1	Measurement mode	SING → Single shot CON → Continuous measurement ALT → Alternating measurement CCUR → Cooling curve FAST → Fast measurement

Note: Command not allowed in calibration mode.
 Command is not allowed when a measurement is running.
 RESistance can also be used instead of FRESistance.

8.13.9 SENSE:FRESistance:TIME:CONStant

DESCRIPTION: Sets the load type of the device under test

SYNTAX: SENSE:FRESistance:TIME:CONStant P1

Meaning of parameter Pn

Parameter	Meaning	Value
P1	Time constant i.e. load type of device under test	T1 → Resistive load Z1
		T2 → Inductive load Z2
		T3 → Inductive load Z3

QUERY FORM: SENSE:FRESistance:TIME:CONStant?

RESPONSE: A1

Meaning of response An

Response	Meaning	Value
A1	Time constant i.e. load type of device under test	T1 → Resistive load Z1
		T2 → Inductive load Z2
		T3 → Inductive load Z3

Note: Command not allowed in calibration mode.
 Command is not allowed when a measurement is running.
 RESistance can also be used instead of FRESistance.

RESISTOMAT® Model 2316

8.13.10 SENSE:FRESistance:RANGe?

DESCRIPTION: Can be used to query the measuring range currently in use.

SYNTAX: SENSE:FRESistance:RANGe?

No parameters

QUERY FORM: Query form only

RESPONSE: A1

Meaning of response An

Response	Meaning	Value
A1	Measuring range currently set	1 → 2 mΩ range
		2 → 20 mΩ range
		3 → 200 mΩ range
		4 → 2 Ω range
		5 → 20 Ω range
		6 → 200 Ω range
		7 → 2 kΩ range
		8 → 20 kΩ range
		9 → 200 kΩ range

Note: Command not allowed in calibration mode.
RESistance can also be used instead of FRESistance.

8.13.11 SENSE:FRESistance:RANGe:AUTO

DESCRIPTION: Switches between manual and automatic range-selection.

SYNTAX: SENSE:FRESistance:RANGe:AUTO P1

Meaning of parameter Pn

Parameter	Meaning	Value
P1	Manual or automatic range-selection	1 or ON → Automatic range-selection 0 or OFF → Manual range-selection

QUERY FORM: SENSE:FRESistance:RANGe:AUTO?

RESPONSE: A1

Meaning of response An

Response	Meaning	Value
A1	Manual or automatic range-selection	1 or ON → Automatic range-selection 0 or OFF → Manual range-selection

Note: Command not allowed in calibration mode.
Command is not allowed when a measurement is running.
RESistance can also be used instead of FRESistance.

8.13.12 SENSE:FRESistance:RANGe:UPPer

DESCRIPTION: Sets the maximum permitted measuring range for automatic range-selection.

SYNTAX: SENSE:FRESistance:RANGe:UPPer P1

Meaning of parameter Pn

Parameter	Meaning	Value
P1	Max. measuring range for automatic range-selection	2MOHM → 2 mΩ range
		20MOHM → 20 mΩ range
		200MOHM → 200 mΩ range
		2OHM → 2 Ω range
		20OHM → 20 Ω range
		200OHM → 200 Ω range
		2KOHM → 2 kΩ range
		20KOHM → 20 kΩ range
		200KOHM → 200 kΩ range

QUERY FORM: SENSE:FRESistance:RANGe:UPPer?

RESPONSE: A1

Meaning of response An

Response	Meaning	Value
A1	Max. measuring range for automatic range-selection	2MOHM → 2 mΩ range
		20MOHM → 20 mΩ range
		200MOHM → 200 mΩ range
		2OHM → 2 Ω range
		20OHM → 20 Ω range
		200OHM → 200 Ω range
		2KOHM → 2 kΩ range
		20KOHM → 20 kΩ range
		200KOHM → 200 kΩ range

Note: Command not allowed in calibration mode.
 Command is not allowed when a measurement is running.
 The range must be greater than the minimum permitted measuring range set with SENSE:FRESistance:RANGe:LOWer.
 RESistance can also be used instead of FRESistance.

8.13.13 SENSE:FRESistance:RANGe:LOWer

DESCRIPTION: Sets the minimum permitted measuring range for automatic range-selection.

SYNTAX: SENSE:FRESistance:RANGe:LOWer P1

Meaning of parameter Pn

Parameter	Meaning	Value
P1	Min. measuring range for automatic range-selection	2MOHM → 2 mΩ range
		20MOHM → 20 mΩ range
		200MOHM → 200 mΩ range
		2OHM → 2 Ω range
		20OHM → 20 Ω range
		200OHM → 200 Ω range
		2KOHM → 2 kΩ range
		20KOHM → 20 kΩ range
		200KOHM → 200 kΩ range

QUERY FORM: SENSE:FRESistance:RANGe:LOWer?

RESPONSE: A1

Meaning of response An

Response	Meaning	Value
A1	Min. measuring range for automatic range-selection	2MOHM → 2 mΩ range
		20MOHM → 20 mΩ range
		200MOHM → 200 mΩ range
		2OHM → 2 Ω range
		20OHM → 20 Ω range
		200OHM → 200 Ω range
		2KOHM → 2 kΩ range
		20KOHM → 20 kΩ range
		200KOHM → 200 kΩ range

Note: Command not allowed in calibration mode.
 Command is not allowed when a measurement is running.
 The range must be smaller than the maximum permitted measuring range set with SENSE:FRESistance:RANGe:UPPer.
 RESistance can also be used instead of FRESistance.

8.13.14 SENSE:FRESistance:RANGe:MANual

DESCRIPTION: Sets the measuring range for manual range-selection.

SYNTAX: SENSE:FRESistance:RANGe:MANual P1

Meaning of parameter Pn

Parameter	Meaning	Value
P1	Measuring range for manual range-selection	2MOHM → 2 mΩ range 20MOHM → 20 mΩ range 200MOHM → 200 mΩ range 2OHM → 2 Ω range 20OHM → 20 Ω range 200OHM → 200 Ω range 2KOHM → 2 kΩ range 20KOHM → 20 kΩ range 200KOHM → 200 kΩ range

QUERY FORM: SENSE:FRESistance:RANGe:MANual?

RESPONSE: A1

Meaning of response An

Response	Meaning	Value
A1	Measuring range for manual range-selection	2MOHM → 2 mΩ range 20MOHM → 20 mΩ range 200MOHM → 200 mΩ range 2OHM → 2 Ω range 20OHM → 20 Ω range 200OHM → 200 Ω range 2KOHM → 2 kΩ range 20KOHM → 20 kΩ range 200KOHM → 200 kΩ range

Note: Command not allowed in calibration mode.
 Command is not allowed when a measurement is running and an inductive device under test is set.
 RESistance can also be used instead of FRESistance.

8.13.15 SENSE:AVERAge:COUNT

DESCRIPTION: Sets the number of measurements to be used for calculating the mean resistance.

SYNTAX: SENSE:AVERAge:COUNT P1

Meaning of parameter Pn

Parameter	Meaning	Value
P1	Number of values used for average	Numerical value between 1 and 99

QUERY FORM: SENSE:AVERAge:COUNT?

RESPONSE: A1

Meaning of response An

Response	Meaning	Value
A1	Number of values used for average	Numerical value between 1 and 99

Note: Command not allowed in calibration mode.
Command not allowed when measurement running.

8.13.16 SENSE:CORRection:OFFSet

DESCRIPTION: Start zero-offset measurement for automatic thermal-EMF compensation disabled („MAN ZERO“)

SYNTAX: SENSE:CORRection:OFFSet

No parameter

QUERY FORM: no query form

Note: Command not allowed in calibration mode.
Command not allowed when measurement running.

8.13.17 SENSE:CORRection:OFFSet:AUTO:STATe

DESCRIPTION: Enables/disables the automatic thermal-EMF compensation.

SYNTAX: SENSE:CORRection:OFFSet:AUTO:STATe P1

Meaning of parameter Pn

Parameter	Meaning	Value
P1	Status of autom. Thermal-EMF compensation	1 or ON → Automatic thermal-EMF compensation on 0 or OFF → Automatic thermal-EMF compensation off

QUERY FORM: SENSE:CORRection:OFFSet:AUTO:STATe?

RESPONSE: A1

Meaning of response An

Response	Meaning	Value
A1	Status of autom. Thermal-EMF compensation	1 or ON → Automatic thermal-EMF compensation on 0 or OFF → Automatic thermal-EMF compensation off

Note: Command not allowed in calibration mode.
Command not allowed when measurement running.

8.14 SOURce Subsystem

8.14.1 SOURce:CURRent[:LEVel:IMMediate:AMPLitude]

DESCRIPTION: Sets the measurement current

SYNTAX: SOURce:CURRent[:LEVel:IMMediate:AMPLitude] P1

Meaning of the parameter Pn

Parameter	Meaning	Value
P1	Permitted Access	MINimum → Current low MAXimum → Current high

QUERY FORM: SOURce:CURRent[:LEVel:IMMediate:AMPLitude]?

RESPONSE: A1

Meaning of response An

Response	Meaning	Value
A1	Permitted Access	MINimum → when current low MAXimum → when current high

Note: Command is not allowed in calibration mode.
Command is not allowed when measurement is running.

8.15 IEEE-488.2 commands

8.15.1 *SRE command

DESCRIPTION: Sets the Service Request Enable register.

SYNTAX: *SRE P1

Meaning of parameter Pn

Parameter	Meaning	Value
P1	Contents of the Service Request Enable register	Numerical value between 0 and 255

QUERY FORM: *SRE?

RESPONSE: A1

Meaning of response An

Response	Meaning	Value
A1	Contents of the Service Request Enable register	Numerical value between 0 and 255

8.15.2 *STB? Command

DESCRIPTION: Reads the Status Byte register.

SYNTAX: STB?

No parameter

QUERY FORM: Query form only

RESPONSE: A1

Meaning of response An

Response	Meaning	Value
A1	Contents of the Status Byte register	Numerical value between 0 and 255

8.15.3 *ESE command

DESCRIPTION: Sets the Standard Event Status Enable register.

SYNTAX: *ESE P1

Meaning of parameter Pn

Parameter	Meaning	Value
P1	Contents of the Standard Event Status register	Numerical value between 0 and 255

QUERY FORM: *ESE?

RESPONSE: A1

Meaning of response An

Response	Meaning	Value
A1	Contents of the Standard Event Status register	Numerical value between 0 and 255

8.15.4 *ESR? Command

DESCRIPTION: Reads the Standard Event Status register.

SYNTAX: ESR?

No parameter

QUERY FORM: Query form only

RESPONSE: A1

Meaning of response An

Response	Meaning	Value
A1	Contents of the Standard Event Status register	Numerical value between 0 and 255

8.15.5 *OPC command

DESCRIPTION: Sets the device to the Operation Complete Active state (OCAS).

SYNTAX: *OPC

NOTE: This command has no function on the 2316.
No point to it on the serial port with ANSI protocol.

8.15.6 *RST command

DESCRIPTION: Sets the device to a defined initial state.
Does not affect the setting for the serial port.

SYNTAX: *RST

No parameter

QUERY FORM: No query form

8.15.7 *TST? Command

DESCRIPTION: Self-test query command. The command is recognized by the instrument, but has no further function.

SYNTAX: *TST?

No parameter

QUERY FORM: Query form only

RESPONSE: A1

Meaning of response An

Response	Meaning	Value
A1		Returns a1.

8.15.8 *WAI command

DESCRIPTION: This command configures the device to handle all commands sequentially. This command has no function on the RESISTOMAT® 2316 because commands are always handled sequentially anyway. The command is merely recognized.

SYNTAX: *WAI

No parameter

QUERY FORM: No query form

Note: No function on 2316

RESISTOMAT® Model 2316

8.15.9 *CLS command

DESCRIPTION: Clears the SCPI error buffer. Resets the Status Byte register.
 Resets the Standard Event Status register.
 Resets the Operation Status Event register.
 Resets the Questionable Status Event register.

SYNTAX: *CLS

No parameter

QUERY FORM: No query form

8.15.10 *IDN? Command

DESCRIPTION: Retrieves various information for device identification.

SYNTAX: *IDN?

No parameter

QUERY FORM: Query form only

RESPONSE: A1, A2, A3, A4, A5, A6

Meaning of response An

Response	Meaning	Value
A1	Device identification	RESISTOMAT® 2316
A2	Derivative	V0000 → 1 Amp instrument V0001 → 3 Amp instrument
A3	Serial number	String with up to 10 characters
A4	Version	String with up to 11 characters
A5	Calibration date	Date in the form dd.mm.yy
A6	Calibration counter	Sequential number

8.15.11 *RCL command

DESCRIPTION: Can be used to select a measurement program (0 to 15).

SYNTAX: *RCL P1

Meaning of parameter Pn

Parameter	Meaning	Value
P1	Number of the measurement program	Numerical value between 0 and 15

QUERY FORM: *RCL?

RESPONSE: A1

Meaning of response An

Response	Meaning	Value
A1	Number of the present measurement program	Numerical value between 0 and 15

8.16 Programming examples

QBasic examples

These two examples were written using Quick-Basic, and in both methods shown retrieve the info string.

8.16.1 Communication using „selection with response“

```

REM *****
REM **
REM **      2316_1.bas      Developed by:MN,Li      **
REM **                                Changed by:CS      **
REM **      Communication      Prog. language: Qbasic 1.1      **
REM **      exe-File created with QB 4.5      **
REM **      with selection with      **
REM **      response      date: 09.12.2004      **
REM **      example: ask for ID-string      **
REM **                                **
REM *****

REM (1) Definition of ASCII-Control Characters

REM STX Start of text: 0x02
STX$ = CHR$(2)

REM ETX End of text: 0x03
ETX$ = CHR$(3)

REM EOT End of transmission: 0x04
EOT$ = CHR$(4)

REM ENQ Enquiry: 0x05
ENQ$ = CHR$(5)

REM ACK Acknowledge: 0x06
ACK$ = CHR$(6)

REM LF line feed: 0x0a
LF$ = CHR$(10)

REM CR carriage return: 0x0d
CR$ = CHR$(13)

REM NAK not acknowledge: 0x15
NAK$ = CHR$(21)

REM+*****
REM Dialog: Selection and opening/initialisation of PC-Interface
REM+*****

CLS
INPUT „Which interface do you want to use? (1 -> COM1, 2 -> COM2)“; a
IF ((a <> 1) AND (a <> 2)) THEN PRINT „illegal Interface“: END
IF (a = 1) THEN com$ = „COM1“
IF (a = 2) THEN com$ = „COM2“
openstr$ = com$ + „:9600,N,8,1“
PRINT

REM ** rs232 initialisation
OPEN openstr$ FOR RANDOM AS #3

REM+*****
REM Ask Device (adr 0) for ID-String with Mode „selection with response“
REM (one of the two communication modes)
REM+*****

```

```
PRINT „——>>>> Connecting Device with adress 1....“

REM ** Sending „selection supervisory sequence“ and pick up answer send EOT first to end
other (probably unanswered) enquiries
PRINT #3, EOT$ + „0000“ + „sr“ + ENQ$
REM clear answer string

ant$ = „“
REM read characters from serial interface
ant$ = INPUT$(1, #3)

REM new char should be an ACK
IF ant$ <> ACK$ THEN PRINT „Communication error, not (ACK) received but:“; ant$
PRINT „selection supervisory string sent“
REM press ,enter` to proceed
INPUT „ENTER TO GO ON“; a$: a$ = „“

REM ** Sending command „INFO?“ to 2316 (enclosed with STX and ETX)
PRINT #3, STX$ + „*idn?“ + ETX$

REM clear answer string
ant$ = „“
REM read characters from serial interface
ant$ = INPUT$(1, #3)

REM new char should be an ACK
IF ant$ <> ACK$ THEN PRINT „Communication error, not (ACK) received but:“; ant$

REM !!IMPORTANT!! de-adress before start polling
PRINT #3, EOT$

PRINT „ID-Enquiry sent“
REM press ,enter` to proceed
INPUT „ENTER TO GO ON“; a$: a$ = „“

REM 9310 wants to answer now and waits for polling

REM start polling
PRINT #3, „0000“ + „po“ + ENQ$

REM clear answer string
ant$ = „“

REM initialize variable char$ to anything but ETX
char$ = STX$
REM read from serial interface until ETX and add to answer-string
WHILE (char$ <> ETX$)
    char$ = INPUT$(1, #3)
    ant$ = ant$ + char$
WEND

REM ID-string received, send ACK
PRINT #3, ACK$

REM Printing „Dev 0 INFO:“ on PC-screen:
PRINT „DEVICE 0 answers: „, ant$

REM Reading EOT from 2316
ant$ = „“
ant$ = INPUT$(1, #3)

REM new char should be an EOT
IF ant$ <> EOT$ THEN PRINT „Communication error, not (EOT) received but:“; ant$

PRINT „Program has ended successfully“

END
```

8.16.2 Communication using „fast selection“

```

REM *****
REM **
REM **      2316_2.bas      Developed by:MN,Li      **
REM **                                Changed by:CS      **
REM **                                Prog. language: Qbasic 4.5      **
REM ** Communication      exe-File created with QB 4.5      **
REM ** with fast selection      date: 09.12.2004      **
REM ** example: ask for ID-string with fast selection      **
REM *****

REM Definition of ASCII-Control Characters

REM STX Start of text: 0x02
STX$ = CHR$(2)

REM ETX End of text: 0x03
ETX$ = CHR$(3)

REM EOT End of transmission: 0x04
EOT$ = CHR$(4)

REM ENQ Enquiry: 0x05
ENQ$ = CHR$(5)

REM ACK Acknowledge: 0x06
ACK$ = CHR$(6)

REM LF line feed: 0x0a
LF$ = CHR$(10)

REM CR carriage return: 0x0d
CR$ = CHR$(13)

REM NAK not acknowledge: 0x15
NAK$ = CHR$(21)

REM+++++++
REM Dialog: Selection and opening/initialisation of PC-Interface
REM+++++++

CLS
INPUT „Which interface do you want to use? (1 -> COM1, 2 -> COM2)“; a
IF ((a <> 1) AND (a <> 2)) THEN PRINT „illegal Interface“: END
IF (a = 1) THEN com$ = „COM1“
IF (a = 2) THEN com$ = „COM2“
openstr$ = com$ + „:9600,N,8,1“
PRINT

REM ** rs232 initialisation
OPEN openstr$ FOR RANDOM AS #3

PRINT „Please set up the 2316 with:“
PRINT „ baudrate = 9600, Data bits = 8,“
PRINT „ Stopp bits = 1, No parity, no blockcheck“
PRINT „ adress 0“
PRINT

```

```
REM+++++
REM Ask Device (adr 0) for ID-String with Mode „fast selection“
REM (one of the two communication modes)
REM All commands in the user manual are described in this mode
REM+++++

PRINT „——>>>> Connecting Device with adress 0...“

REM send EOT first to end other (probably un-answered) enquiries (strongly recommended)
PRINT #3, EOT$

REM Create and send command
PRINT #3, „0000“ + „sr“ + STX$ + „*IDN?“ + ETX$

REM clear answer string

ant$ = „“
REM read characters from serial interface
ant$ = INPUT$(1, #3)

REM new char should be an ACK
IF ant$ <> ACK$ THEN PRINT „Communication error, not (ACK) received but:“; ant$

REM press ,enter` to proceed
INPUT „ENTER TO GO ON“; a$: a$ = „“

REM !!IMPORTANT!! de-adress before start polling
PRINT #3, EOT$

REM 9310 wants to answer now and waits for polling

REM start polling
PRINT #3, „0000“ + „po“ + ENQ$

REM clear answer string
ant$ = „“

REM initialize variable char$ to anything but ETX
char$ = STX$
REM read from serial interface until ETX and add to answer-string
WHILE (char$ <> ETX$)
    char$ = INPUT$(1, #3)
    ant$ = ant$ + char$
WEND

REM ID-string received, send ACK
PRINT #3, ACK$

REM Printing „INFO“ on PC-screen:
PRINT „Device (0) answers: „, ant$

REM Reading EOT from 2316
ant$ = „“
ant$ = INPUT$(1, #3)

REM new char should be an EOT
IF ant$ <> EOT$ THEN PRINT „Communication error, not (EOT) received but:“; ant$

PRINT „Program has ended successfully“

END
```

8.16.3 Programming Example

Program lines for the transmission of meas. values from RESISTOMAT® 2316 to the PC

Ask for device model and identification:

```

1. PC:      <EOT>0000sr<STX>*idn?<LF><ETX>
2. 2316:    <ACK>

3. PC:      <EOT>0000po<ENQ>
4. 2316:    <STX>RESISTOMAT2316, [device version],
            [serial number],[software version]<CR><LF><ETX>
5. PC:      <ACK>
6. 2316:    <EOT>

```

Measuring start:

```

7. PC:      <EOT>0000sr<STX>init<LF><ETX>
8. 2316:    <ACK>

```

Check and wait till a meas. value is available. Read SCPI status operation condition register and mask out Bit 8 (EOC) → if EOC=1 than a new meas. value is available and the value you can read with the following step **fetc?**

```

9. PC:      <EOT>0000sr<STX>S:O:C?<LF><ETX>
10. 2316:   <ACK>

11. PC:     <EOT>0000po<ENQ>
12. 2316:   <STX>[register value]<CR><LF><ETX>
13. PC:     <ACK>
14. 2316:   <EOT>

```

Read meas. value in PC

```

15. PC:     <EOT>0000sr<STX>fetc?<LF><ETX>
16. 2316:   <ACK>

17. PC:     <EOT>0000po<ENQ>
18. 2316:   <STX>[meas. value]<CR><LF><ETX>
19. PC:     <ACK>
20. 2316:   <EOT>

```

For a new meas. value go to line 9.

For the end go to line 21.

Measuring end:

```

21. PC:     <EOT>0000sr<STX>abor<LF><ETX>
22. 2316:   <ACK>

```

Note: At our homepage <https://goo.gl/79Y4vw> you can download free of charge the software "Serial Console" where you can check the different instructions.

9 Maintenance, Customer service, Shipping, Cleaning

9.1 Maintenance

The RESISTOMAT® model 2316 requires no maintenance by the user. Any repairs that may be needed must be performed only at the manufacturer's premises. Recalibration is recommended every 12 months.

9.2 Customer service

Customer service department

For repair inquiries, please telephone our Service department on +49-7224-645-53, or email: service@burster.com (Germany only). If you are outside Germany, you should contact your burster agent (see also www.burster.com).

Please have the serial number to hand. The serial number is essential to establishing the definite technical status of the instrument and providing help quickly. You will find the serial number on the type plate of the RESISTOMAT® model 2316.

Contact person

If you have any questions relating to the RESISTOMAT® model 2316, please go directly to burster praezisionsmesstechnik gmbh & co. kg, or if outside Germany, please contact your burster agent (see also www.burster.com).

Head office

burster praezisionsmesstechnik gmbh & co kg
Talstr. 1 - 5
76593 Gernsbach Germany
Telephone: +49-7224-645-0
Fax: +49-7224-645-88
Email: info@burster.com

Shipping instructions

If the RESISTOMAT® model 2316 needs to be returned for repairs, please note the following requirements for packing and shipping: The original or equivalent packaging should be used whenever possible for shipping. The warranty does not cover transportation damage caused by inadequate packaging. If you have a problem with the instrument, please attach a note to the case summarizing the fault. If you also include a name, department, fax number and your phone number and e-mail address for possible queries, this will help to speed up the process.

Factory warranty

burster guarantees trouble-free operation of the instrument for 24 months after delivery. Any repairs required during this time will be made without charge. Damage caused by improper use of the equipment is not covered by the warranty. The technical data can change at any time without notification. We also state explicitly that we do not accept liability for consequential damage.

Cleaning

Please do not use any cleaning agents that contain organic solvents or concentrated inorganic constituents. Thus never use acetone, toluene, xylene, benzene, ethanol, isopropyl alcohol, naptha etc. Usually just a cotton cloth moistened with a mild soap solution is sufficient. Never use cleaning agents containing abrasives.

10 Appendix

10.1 Technical data

Only values that include tolerances or limits are data covered by the warranty. Values that do not include tolerances are provided for information and do not come under the warranty.

The instrument is designed for easy servicing and is housed in a rugged metal case. The individual components are easily accessible, ensuring ideal servicing conditions.

Display counts:	approx. 21000 counts, last digit can be disabled
Display:	high-contrast graphics LCD with bright, white LED back lighting, Black and white display 264 * 64 Dots, approx. 127mm * 34 mm
Keypad:	robust membrane keypad, good tactile feedback, suitable for use with gloves.
Operation:	via keypad or interface
Measuring error:	$\leq \pm 0.03$ % of reading ± 3 counts
Temperature drift:	< 50 ppm/K

Range	Resolution	Measurement current low	Measurement current high
*2 mΩ	0,0001 mΩ	3 A	3 A
20 mΩ	0,001 mΩ	1 A	1 A
200 mΩ	0,01 mΩ	100 mA	1 A
2 Ω	0,0001 Ω	10 mA	1 A
20 Ω	0,001 Ω	10 mA	100 mA
200 Ω	0,01 Ω	1 mA	10 mA
2 kΩ	0,1 Ω	1 mA	1 mA
20 kΩ	1 Ω	100 μA	100 μA
200 kΩ	10 Ω	100 μA	10 μA

*only RESISTOMAT® model 2316-V0001

Measuring technique:	ratiometric constant current technique
Sample rate:	approx. 5 / s in the display
Single shot:	Measurement time approx. 500 ms (step to 99.97 %) for purely resistive devices under test
Zero-offset/Thermal EMF compensation:	Automatic before start of measurement, can be disabled
Test connection:	4-wire technology, 5-pin circular socket 4 x 4 mm banana plug sockets
Ground connection:	separate FE PE, 250 V potential to ground
Compliance voltage:	approx. 5 V max.
Selection of measuring range:	manual and automatic (not for inductive loads)
Inductive loads:	three different measured parameters preset to give optimum speed, protection circuit, discharge of inductance

Measurement fault:	oscillation detection open-circuit detection Pt100 absence detection
Warm-up time:	< 15 min until error tolerances are reached
Auxiliary power:	100 ... 240 V _{AC} , 50/60 Hz
Power consumption:	30 VA max.
Protection circuit:	circuit providing protection against induction voltages and against external voltages up to 400 V _{eff}
Temperature compensation: pyrometer,	Measurement inputs for Pt 100 and 0 to 10V TC can be defined, known materials can be selected.
Limits:	can be entered via keypad
Control inputs:	PLC and foot switch
Evaluation results:	PLC level and / or relay 24 V / 1 A * Um.
PLC level:	positive, optionally negative
Interfaces:	RS232, USB, Ethernet
Printer output:	RS232, measured value, temp., comparator evaluation
User language:	German, English, French, Italian, Spanish
Device program memory	for 16 device programs
Case:	rugged table-top case made of aluminum section with plastic frame, RAL 7035
Case dimensions (HxWxD):	106 x 247 x 275 [mm]
Weight:	approx. 3.5 kg
Safety:	usual EN standards, CE, EN 61010-1
Use:	indoors
Altitude:	up to 2000 m above sea level
Operating temperature range:	0 ... <u>±23</u> ... + 50 °C
Storage temperature range:	0 ... + 70 °C
Humidity: to 50 % at T max, no condensation	up to 31 °C 80 %, decreasing linearly above that temp.
Design: (dusty, normal EMC interference)	suitable for industrial use in a production environment
Degree of protection:	IP 40
Overvoltage category:	2
Degree of pollution:	2
Class of protection:	1
Position for use:	horizontal

10.2 Calibration and Adjustment

The instrument is adjusted digitally. PC software 2316-P001 (purchased separately) and a range of series 1240 calibration resistances are required for the calibration and/or the adjustment.

10.3 Error messages and troubleshooting

Fault	Possible cause	Remedial action
Display does not come on	Mains fuse blown. Mains lead faulty or loose.	Remove mains lead. Replace mains fuse 3,15 A slow-blowing. Check mains lead.
Flashing zeros, Overload indicator, Overdriven	Wrong measuring range selected, test lead open-circuit +U or -U, load impedance too high.	Select correct measuring range. Connect test leads correctly.
Display difficult to read	Adjust contrast via interface or manually Temperature range exceeded	Set contrast initially to 50 %. Run instrument at correct temperature.
Measured values flickering	Interference picked up by test leads	Position test leads differently.
Error messages Current source oscillating	Unsuitable load	Select next longer time constant (Z1 or Z2)
Error message	Fuse in current source under test	Short-circuit supply lead to device Current too low has blown and disconnected. Remove mains lead. Replace fuse. Use only this fuse type: Superquick-acting fuse 10, 6.3*32 mm, 600VAC, 50000 breaking capacity; RS-Components #209-9383 (in Germany) Check test leads
Error message Pt100 fault	Pt100 contact problems	Not present, check leads and connectors to Pt100 sensor.
Error message Pyrometer	0-10 V exceeded	Check pyrometer voltage
Error message Measurement current too high	Current source faulty	Return instrument

Number	Description
[1]	Time constant Z1, single/duration/alternating operation, current too low or ADC overdriven
[2]	Autozero, single/duration/alternating operation, offset measurement: AD value too large or too small for offset
[3]	Time constant Z1, single/duration/alternating operation, current too high or ADC underdriven, or for autorange: no suitable range can be selected
[4]	Autorange operation : Current too high or ADC underdriven, no suitable range can be selected
[5]	Autorange operation : current too low or ADC overdriven, no suitable range can be selected
[6]	Manual offset measurement: AD value too large or too small for offset
[7]	Time constant Z1, cool-down operation, current too high or ADC underdriven
[8]	Time constant Z1, cool-down operation, current too low or ADC overdriven

M 20 kOhm	Z1	SINGLE	A 100.0 C°	TC ± 1500	15
					
[X]					
(-) 0	START		STOP		AUTOZERO

Internal device errors

After power-up, the instrument checks the calibration data in the data memory, the non-volatile variables in the data memory and the EEPROM on the analog card. Since more than one error can occur at once, the errors are binary coded and displayed on the LCD in the event of an error.

- Bit 0 set means that non-volatile data in the RAM has been lost.
- Bit 1 set means that a new device software version has been found (version number)
- Bit 2 set means that the EEPROM has not been programmed yet or is faulty.
- Bit 3 set means that calibration data in the data memory has been lost.

The error code is displayed as a hexadecimal code:

Bit3	Bit2	Bit1	Bit0	Error code
0	0	0	1	0x01
0	0	1	0	0x02
0	0	1	1	0x03
0	1	0	0	0x04
0	1	0	1	0x05
0	1	1	0	0x06
0	1	1	1	0x07
1	0	0	0	0x08
1	0	0	1	0x09
1	0	1	0	0x0A
1	0	1	1	0x0B
1	1	0	0	0x0C
1	1	0	1	0x0D
1	1	1	0	0x0E
1	1	1	1	0x0F

This error menu can only be closed by entering a code:

Please notify our service department, Phone +49(0)7224-645-0.

11 Disposal



Battery disposal

As an end user, you are required by law (battery ordinance) to return all used batteries and rechargeable batteries; the disposal through household waste is prohibited. By buying the herein described device you are concerned by this law. Please dispose of your batteries and rechargeable batteries correctly. Hand them to waste disposal sites either at your premises or at our company or at any place where batteries/rechargeable batteries are sold.

Equipment Disposal

Please fulfill your legal obligations and dispose of unserviceable equipment in accordance with applicable legal requirements. Thus you contribute to environmental protection.

