

OPERATION MANUAL

Tension and Compression Load Cell Model 8524

© 2021 burster
präzisionsmesstechnik gmbh & co kg
All rights reserved

Manufacturer:
burster
präzisionsmesstechnik gmbh & co kg
Talstr. 1-5 Postfach 1432
76593 Gernsbach 76587 Gernsbach
Germany Germany

Valid from: February 09, 2021

Tel.: +49 7224 645-0
Fax: +49 7224 645-88
Email: info@burster.de
www.burster.de

Warranty disclaimer

All information in the present documentation was prepared and compiled with great care and reproduced in accordance with effective control measures. No warranty is provided for freedom from errors. We reserve the right to make technical changes. The present information as well as the corresponding technical data can change without notice. Reproduction of any part of this documentation or its processing or revision using electronic systems is prohibited without the manufacturer's prior written approval.

Components, devices and measurement sensors made by burster präzisionsmesstechnik (hereinafter referred to as the "product") are the result of targeted development and meticulous research. From the date of delivery, burster provides a warranty for the proper condition and functioning of these products covering material and production defects for the period specified in the warranty document accompanying the product. However, burster waives any guarantee or warranty obligations or any additional liability for consequential damages caused by improper use of the product, in particular the implied guarantee of success in the market as well as the suitability of the product for a particular purpose. Furthermore, burster assumes no liability for direct, indirect or incidental damages or for consequential or other damages arising from the provision and use of the present documentation.

The measurement solution.



EU-Konformitätserklärung (nach EN ISO/IEC 17050-1:2010) EU-Declaration of conformity (in accordance with EN ISO/IEC 17050-1:2010)

Name des Ausstellers: burster präzisionsmesstechnik gmbh & co kg
Issuer's name:

Anschrift des Ausstellers: Talstr. 1-5
Issuer's address: 76593 Gernsbach, Germany

Gegenstand der Erklärung: Kraftsensor
Object of the declaration: Load Cell

Modellnummer(n) (Typ): 84xx; 85xx
Model number / type: 84xx; 85xx

Diese Erklärung beinhaltet obengenannte Produkte mit allen Optionen
This declaration covers all options of the above product(s)

Das oben beschriebene Produkt ist konform mit den Anforderungen der folgenden Dokumente:
The object of the declaration described above is in conformity with the requirements of the following documents:

Dokument-Nr. <i>Documents No.</i>	Titel <i>Title</i>	Ausgabe <i>Edition</i>
2011/65/EU	Richtlinie zur Beschränkung der Verwendung bestimmter gefährlicher Stoffe in Elektro- und Elektronikgeräten <i>Directive on the restriction of the use of certain hazardous substances in electrical and electronic equipment</i>	2011
2014/30/EU	Richtlinie zur Harmonisierung der Rechtsvorschriften der Mitgliedsstaaten über die Elektromagnetische Verträglichkeit <i>Directive on the harmonization of the laws of the Member States relating to electromagnetic compatibility</i>	2014
EN 61326-1	Elektrische Mess-, Steuer-, Regel- und Laborgeräte – EMV-Anforderungen – Teil 1: Allgemeine Anforderungen <i>Electrical equipment for measurement, control and laboratory use – EMC requirements – Part 1: General requirements</i>	2013
EN 61326-2-3	Elektrische Mess-, Steuer-, Regel- und Laborgeräte – EMV-Anforderungen – Teil 2-3: Besondere Anforderungen <i>Electrical equipment for measurement, control and laboratory use – EMC requirements – Part 2-3: Particular requirements</i>	2006

Gernsbach 20.04.2016 i.V. Christian Karius
Ort / place Datum / date Quality Manager

Dieses Dokument ist entsprechend EN ISO/IEC 17050-1:2010 Abs. 6.1g ohne Unterschrift gültig
According EN ISO/IEC 17050 this document is valid without a signature.

burster präzisionsmesstechnik gmbh & co kg · Talstr. 1-5 DE-76593 Gernsbach (P.O.Box 1432 DE-76587 Gernsbach) · Tel. +49-7224-6450 · Fax 645-88
www.burster.com · info@burster.com · burster is ISO 9001:2008 certified

Geschäftsführer/Managing Director: Matthias Burster · Handelsregister/Trade Register: Gernsbach · Registergericht/Register Court: Mannheim HRA 530170
Kompl./Gen. Partn.: burster präzisionsmesstechnik Verwaltungs-GmbH · Handelsregister/Trade Register: Gernsbach · Registergericht/Register Court: Mannheim HRB 530130
UST-Identnr./VAT No. DE 144 005 098 · Steuernr./Tax Ident No. 39454/10503
Commerzbank AG Rastatt Kto./Acc. 06 307 073 00 BLZ/Bank code 662 800 53 · Volksbank Baden-Baden* Rastatt eG Kto./Acc. 302 082 00 BLZ/Bank code 662 900 00

Contents

1	For your safety	6
1.1	Symbols used in the operating manual	6
1.1.1	Signal words	6
1.1.2	Pictograms	6
2	Introduction	7
2.1	Intended use.....	7
2.1.1	Customer service department.....	7
2.1.2	Contact person.....	7
2.2	Download the test certificate	7
2.3	Ambient conditions	7
2.3.1	Storage.....	8
2.3.2	Operating conditions	8
2.3.3	Restrictions on use	8
2.3.4	Cleaning.....	8
2.4	Personnel	9
2.5	Contents of pack	9
2.6	Unpacking	9
2.7	Warranty.....	9
2.8	Maintenance.....	9
2.8.1	Recalibration	9
2.9	Conversions and modifications	10
3	Concept and general information	11
3.1	Mechanical design.....	11
3.2	Principle of operation.....	11
3.2.1	Spring element.....	11
3.2.2	Strain gages	11
3.2.2.1	Strain gage wiring.....	12
3.2.2.2	Full-scale deflection.....	12
3.2.2.3	External forces.....	12
3.2.3	Overload protection.....	13
4	Using the instrument for the first time	14
4.1	Grounding and equipotential bonding	14
5	Installation	15
5.1	Mechanics	15
5.2	Fixing method	16
5.3	Electrical system, evaluation instrumentation	17
5.3.1	Connector pin assignment	17

Tension and Compression Load Cell 8524

5.3.1.1	Option 8524-xxxx-xxBxxxxx	18
5.3.1.2	Option 8524-xxxx-xxTxxxxx	19
5.3.1.3	Option 8524-xxxx-xxExxxxx	19
5.3.1.4	Option 8524-xxxx-xxFxxxxx	20
5.3.1.5	Option 8524-xxxx-xxHxxxxx	20
6	Measurement chain calibration	21
7	Technical data	22
7.1	Electromagnetic compatibility	22
7.1.1	Interference immunity	22
7.1.2	Interference emission	22
8	Accessories available	23
9	Disposal.....	24



1 For your safety

The following symbols are used in this operation manual to warn of hazards.

1.1 Symbols used in the operating manual

1.1.1 Signal words



The following signal words are used in the operating manual according to the specified hazard classification.

	DANGER
High degree of risk: indicates a hazardous situation which, if not avoided, will result in death or serious injury.	
	WARNING
Moderate degree of risk: indicates a hazardous situation which, if not avoided, may result in death or serious injury.	
	CAUTION
Low degree of risk: indicates a hazardous situation which, if not avoided, could result in minor or moderate injury.	
NOTICE	
Property damage to the equipment or the surroundings will result if the hazard is not avoided.	

Note: It is important to heed these safety notices in order to ensure you handle the model 8524 tension and compression load cell correctly.

IMPORTANT: Follow the information given in the operating manual.

1.1.2 Pictograms

	Hazard warning
	Observe the advice for protecting the load cell.

2 Introduction

IMPORTANT: Read the operating manual carefully before using the equipment, and keep for future reference.

2.1 Intended use

The load cells in the 8524 model series are primarily designed for the measurement of force in production equipment, using newtons (N) as the unit of measurement. The local gravitational acceleration ($g \approx 9.81 \text{ m/s}^2$) must be taken into account when determining masses.

2.1.1 Customer service department

For repair inquiries, please call our customer service department on +49 7224 645-53.

Please have the serial number to hand. The serial number is essential to establishing the definite technical status of the instrument and providing help quickly. You will find the serial number on the type plate of the model 8524 tension and compression load cell.

2.1.2 Contact person

If you have any questions relating to the model 8524 tension and compression load cell, please contact your representative or go directly to burster präzisionsmesstechnik gmbh & co. kg.

Head office

burster präzisionsmesstechnik
gmbh & co kg
Talstrasse 1-5
76593 Gernsbach
Germany

Phone: +49 7224 645-0
Fax: +49 7224 645-88
Email: info@burster.de

2.2 Download the test certificate

You have the option to download the test certificate for your model 8524 tension and compression load cell online via our website (www.burster.de). The serial number of your model 8524 tension and compression load cell is required for the download.

2.3 Ambient conditions

Please note the following temperature ranges:

- Rated temperature range: +15 °C ... +70 °C
- Operating temperature range: -30 °C ... +80 °C

2.3.1 Storage

The model 8524 tension and compression load cell must be stored under the following conditions:

- dry
- no condensation
- temperature between 0 °C and 60 °C

Note: Provided the storage conditions have been observed, no special steps need to be taken after storage and prior to commissioning.

2.3.2 Operating conditions

	NOTICE
	<p>Only connect the model 8524 tension and compression load cell to instrumentation amplifiers that are fitted with a safety transformer to EN 61558. Transmitters connected to the outputs or other devices that are galvanically connected to the sensor's signal lines must also be fitted with safety transformers to EN 61558.</p>



- Only connect the model 8524 tension and compression load cell to instrumentation amplifiers that are fitted with a safety transformer to EN 61558.
- Transmitters connected to the outputs or other devices that are galvanically connected to the sensor's signal lines must also be fitted with safety transformers to EN 61558.

2.3.3 Restrictions on use

The model 8524 tension and compression load cell does not pose a hazard if used within its specification and in accordance with the safety regulations.

The manufacturer does not accept liability for any personal injury or property damage arising from improper installation or operation, or from misinterpretation of measurement results.

2.3.4 Cleaning

	 CAUTION
	<p>Disconnect the model 8524 tension and compression load cell from the electrical supply before cleaning.</p>

Disconnect the model 8524 tension and compression load cell from the power supply and use a dry cloth to clean it.

	NOTICE
	<p>Do not immerse the model 8524 tension and compression load cell in water or hold it under running water. Do not use strong cleaning agents as these may damage the model 8524 tension and compression load cell. Clean the model 8524 tension and compression load cell using a dry cloth.</p>



2.4 Personnel

Personnel must be familiar with the relevant regulations. They must follow these regulations. Only trained personnel who are familiar with the applicable safety regulations are permitted to operate the model 8524 tension and compression load cell.

2.5 Contents of pack

- Tension and compression load cell, model 8524
- Test certificate

2.6 Unpacking

	 CAUTION
<p>Never switch on the model 8524 tension and compression load cell if it shows signs of damage incurred in transit. Only ever use the model 8524 tension and compression load cell under the conditions specified in this operating manual.</p>	

Inspect the model 8524 tension and compression load cell for damage. If you suspect that the unit has been damaged during shipping, notify the delivery company within 72 hours.

The packaging should be retained by a representative of the manufacturer and/or the delivery company.

The model 8524 tension and compression load cell should be shipped only in its original packaging or in packaging capable of providing an equivalent degree of protection.

2.7 Warranty

burster präzisionsmesstechnik gmbh & co kg provides a manufacturer's warranty for a period of 24 months after delivery.

Any repairs required during this time will be made without charge. This does not include damage arising from improper use.

Please note the following when sending the model 8524 tension and compression load cell in for repair:

- If there is a problem with the sensor, please attach a note to the body of the device summarizing the fault.
- Technical specifications subject to change at any time without notice. We also state explicitly that we do not accept liability for consequential damage.
- The instrument must always be dispatched in suitable packaging.

2.8 Maintenance

2.8.1 Recalibration

The model 8524 tension and compression load cell should be recalibrated by the manufacturer after no more than 12 months.

Note: If the model 8524 tension and compression load cell is used in machines with high cycle rates, recalibration should be carried out sooner.

2.9 Conversions and modifications

Note: The warranty shall be deemed void **immediately** if you open or dismantle the model 8524 tension and compression load cell during the warranty period.

The model 8524 tension and compression load cell does not contain any parts that are intended to be serviced by the user. Only the manufacturer's own qualified personnel are permitted to open the model 8524 tension and compression load cell.

It is not permitted to make any changes to the model 8524 tension and compression load cell without the written agreement of burster präzisionsmesstechnik gmbh & co kg. burster präzisionsmesstechnik gmbh & co kg does not accept liability for damages or injury if this condition is disregarded.

3 Concept and general information

Please refer to the data sheet for the model 8524 precision tension and compression load cell for full details of dimensions, weight, degree of protection etc.

3.1 Mechanical design

In the model 8524 tension and compression load cell, the spring element is designed as a horizontally oriented elastic membrane with a centrally arranged ring.

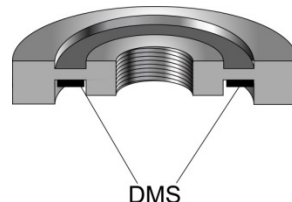

Figure 1: Horizontally oriented membrane

This elastic membrane is deflected by the applied force, resulting in a reduction in the height of the sensor. This deformation cannot be seen by the naked eye. It is measured with the aid of strain gages. In the model 8524 tension and compression load cell, the strain gages are mounted on the underside of the spring element. As a result, they are subject to the same deformation as the spring element.

3.2 Principle of operation

The model 8524 tension and compression load cell utilizes a spring element. The spring element is elastically deformed by the force being measured. Strain gages are used to convert this deformation into an electrical signal. The strain gages and spring element together constitute the measuring element.

3.2.1 Spring element

The spring element is the most important mechanical part of a load cell. Its purpose is to take the force being measured and convert it into a linear extension. It relies on the elastic properties of the material in order to determine the force indirectly.

The materials of which load cells are made must satisfy other conditions in addition to their elastic properties. As a result, only a small number of carefully selected materials come into question for high-quality load cells.

burster goes a step further, using mainly aviation materials that satisfy additional quality requirements instead of DIN materials.

3.2.2 Strain gages

The electrical resistance of a wire rises with increasing length and falling cross-section. When a wire is pulled, it becomes thinner and longer – both of these effects result in an increase in its electrical resistance.

This is the principle on which strain gages are based. In practice, however, strain gages do not consist of a single wire, but of a metal foil laminated onto a carrier material. The metal foil is etched to create a meandering structure (see Abbildung 2).



Figure 2: Foil strain gage

Special techniques are used to mount strain gages manufactured in this way onto the surface of the spring element.

3.2.2.1 Strain gage wiring

In order to reduce undesirable influences on the measurement, the strain gages in model 8524 tension and compression load cells are connected as a Wheatstone bridge. Figure 3 illustrates this wiring in a simplified form.

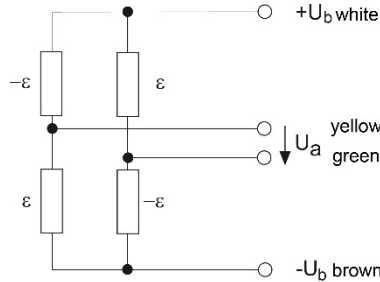

Figure 3: Full-bridge strain gage for model 8524 tension and compression load cells

In addition to the four strain gages shown here, compensation resistors to reduce the effect of temperature and balancing resistors to balance the bridge circuit are also incorporated.

Depending on the version of the model 8524 tension and compression load cell, further resistors for the purpose of standardizing the full-scale output are integrated into the cable or the connector.

The output voltage U_a of the model 8524 tension and compression load cell is calculated as follows:

$$U_a = c * U_b$$

- U_b : Reference excitation voltage
- c : Rated output of the sensor

You can find the rated output “c” on the test certificate for the model 8524 tension and compression load cell. It is typically in the region of 1.5 mV/V \pm 0.25%.

In conjunction with the reference excitation voltage (U_b), in a range of max. 10 V (we recommend 5 V), signals (U_a) of around 7.5 mV are produced at 100% loading of the sensor.

3.2.2.2 Full-scale deflection

On sensors that have an elastic membrane, the load depresses the measuring element in the center of the sensor. This deformation is known as the full-scale deflection, and is so small that it cannot be seen with the naked eye.

On model 8524 tension and compression load cells, the deformation at maximum load is in the region of approx. 80 μ m and is directly proportional to the load.

3.2.2.3 External forces

External forces here refers to any force that acts outside the sensor’s axis of symmetry – particularly transverse forces, bending moments and torsional forces.

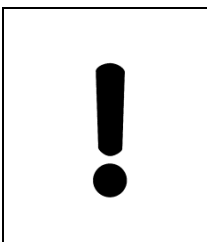

NOTICE

Damage to the model 8524 tension and compression load cell

Avoid vibrations, even if the generated loads remain below the rated load, and avoid external forces acting on the load cell. Design your measuring system in such a way as to prevent these external forces.

IMPORTANT: External forces acting on the model 8524 tension and compression load cell will significantly falsify the measurement result!

3.2.3 Overload protection

burster offers the model 8524 tension and compression load cell optionally with mechanical overload protection for compressive loads up to a measuring range of 0 ... 20 kN (option 8524-XXXX-XXXXX4XX overload protection unidirectional in direction of compression).



- Install an overload protection mechanism.
- Provide pressure limiters for any hydraulic or pneumatic cylinders acting on the model 8524 tension and compression load cell.
- Absolutely avoid any load that applies a sudden force (impulse).

Note: The high spring constant of the model 8524 tension and compression load cell results in high negative accelerations for moving objects. This generates extremely high forces.

If, despite precautions, the model 8524 tension and compression load cell has been overloaded, you will notice this immediately by a change in the output signal for the zero point.

	<h3>NOTICE</h3>
	<p>Get the model 8524 tension and compression load cell checked out if you notice a change in the signal of 5% or more (higher or lower) while no load is present.</p>

4 Using the instrument for the first time

	 <h3>CAUTION</h3>
<p>Never switch on the model 8524 tension and compression load cell if it shows signs of damage incurred in transit. Only ever use the model 8524 tension and compression load cell under the conditions specified in this operating manual.</p>	

	<h3>NOTICE</h3>
<p>Only connect the model 8524 tension and compression load cell to instrumentation amplifiers that are fitted with a safety transformer to EN 61558.</p>	

Note: Transmitters connected to the outputs or other devices that are galvanically connected to the signal lines of the model 8524 tension and compression load cell must also be fitted with safety transformers to EN 61558.

4.1 Grounding and equipotential bonding

All connecting wires (including the cable screening braid) are electrically insulated from the sensor body. The insulation resistance between the connecting wires and the sensor body is measured. The test certificate states that the minimum resistance is greater than 30 MΩ (test voltage 45 V).

5 Installation

5.1 Mechanics

Mounting surface

A high quality measurement depends on a defined deformation of the measuring element under load. To be certain of excluding any unwanted deformations, the model 8524 tension and compression load cell must lie flat on the mounting surface.

The mounting surface must meet the following requirements:

- adequately stable
- hardened, minimum hardness 60 HRC
- polished, preferably lapped, surface quality: N3 (Rz 1), evenness 2 μm
- not coated in any material
- must contain no holes or milled slots, or any centering holes
- be flat

IMPORTANT: Prevent torsional moments, lateral forces and bending forces.

Application of force



This is how it works

1. Apply the force being measured to the model 8524 tension and compression load cell via the central thread.
2. Apply the force centrally exactly along the axis of symmetry.

IMPORTANT: Eliminate any lateral forces and torques.

NOTICE	
	<ul style="list-style-type: none"> • The force application components must be ground flat (never convex) and lapped. • The material must be hardened, not just surface-hardened, and have 60 HRC hardness. • In the force application component there must not be any holes in the effective surfaces such as centering holes for lathes or grinding machines. • The specifications are valid exclusively with the provided load buttons.

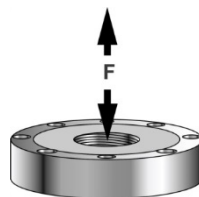



Figure 4: Applying force to the 8524

Note: burster offers pull plates (model 8590) for all measuring ranges of this model 8524 tension and compression load cell. These allow force to be applied on both sides via the central internal thread.

Overload

You can recognize an overload from an increased output signal at no load. Bending plates are relatively insensitive to overloading.

Note: Check the model 8524 tension and compression load cell if the signal increases by more than approx. 5%.

	NOTICE
	<ul style="list-style-type: none"> Do not apply sudden loads to the model 8524 tension and compression load cell. Dynamic loads above 70% of the rated force reduce the life of sensors. If used as a weighing device via axles or entire vehicles, use design measures to absorb the dynamic loading (due to driving onto ramps, braking vehicles, etc.) Make sure that the load does not generate any lateral forces. Use design measures to prevent lateral forces caused by thermal expansion if the model 8524 tension and compression load cell is used as a weighing device on containers.

5.2 Fixing method

The entire contact surface of the model 8524 tension and compression load cell must lie on a hardened (60 HRC), flat, ground or lapped mounting surface.

Bolts

Note: Refer to the latest data sheet for the maximum bolt torques for mounting the model 8524 tension and compression load cell. In addition, we recommend monitoring the sensor's output signals during installation via a display to detect and prevent possible improper loads during installation at an early stage.

Only use bolts that have the following characteristics:

- Bolt strength 12.9 or higher
- Hex socket head bolts to DIN 912
- Countersinks to DIN 74 Km

Measuring ranges up to 0 to 2 kN:

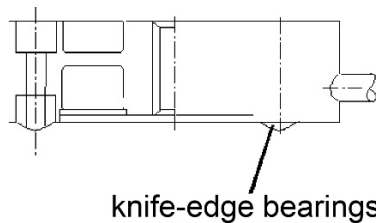

Figure 5: 3 through-holes with point-contact mounts for three-point mounting

Measuring ranges from 0 to 5 kN:

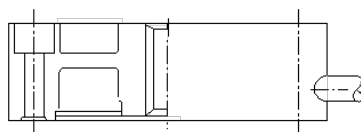

Figure 6: 6 or 8 through-holes

Tension and Compression Load Cell 8524

Cable



This is how it works

1. Install the cable so that it does not vibrate.
2. For a standard sensor, do not shorten the cable between the sensor and the standardization board.
3. Ensure sufficiently large bending radiuses for the cable.

	NOTICE
	<ul style="list-style-type: none"> Relieve the bending stress exerted by the connecting cable on the cable sleeve, at the sensor housing. Avoid pulsating or alternating loads on the cable sleeve. Avoid vibrating the cables so that the cable sheath is not damaged. Protect the cables from strain. Protect the model 8524 tension and compression load cell from vapors and liquids. For a standard sensor, do not shorten the cable between the sensor and the standardization board.

5.3 Electrical system, evaluation instrumentation

The output signal from the model 8524 tension and compression load cell, with an excitation voltage of 10 V, is 15 mV max. Therefore for a measurement accuracy of 0.15% you will need a resolution of approx. 10 μ V or better. Interference affects the model 8524 tension and compression load cell, cables and measurement electronics accordingly.

The following points apply to the sensor's electrical connection:

	NOTICE
	<ul style="list-style-type: none"> Position the model 8524 tension and compression load cell outside the electromagnet field of high-energy equipment. This includes transformers, motors, contactors, frequency converters and so forth. Otherwise the electromagnetic fields from such equipment will act with their full effect on the measuring chain, causing incorrect measurements. Route the measuring leads separately from power cables. If the measuring leads are laid parallel to power cables, the latter will cause inductive and capacitive interference.

Note: You can place an extra screen over the measuring cable for additional protection, or run it through a metal tube or pipe.

5.3.1 Connector pin assignment

The model 8524 tension and compression load cell is supplied with an open cable end. The model 8524 tension and compression load cell is optionally fitted with connectors for burster display and calibration equipment.

Note: For optionally supplied display and calibration devices, please follow the operating instructions for the device to ensure compatibility.

Wire colors for model 8524 tension and compression load cell with open cable ends

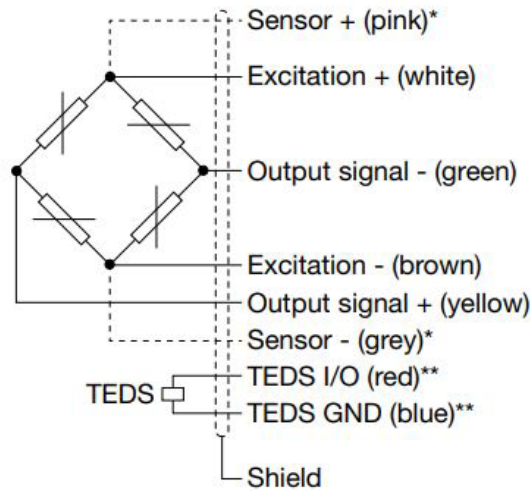

Figure 7: Wire colors for model 8524 tension and compression load cell

Description for Figure 7:

*: Only with extended cable over 5 m in length

** : Optional

5.3.1.1 Option 8524-xxxx-xxBxxxxx

Connection to burster devices with 9-pin D-sub socket with 6-wire system

IMPORTANT: The tension and compression load cell cannot be connected to the Sensormaster 9163 with this pin assignment.

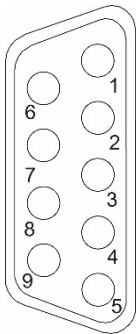

Figure 8: Device connection

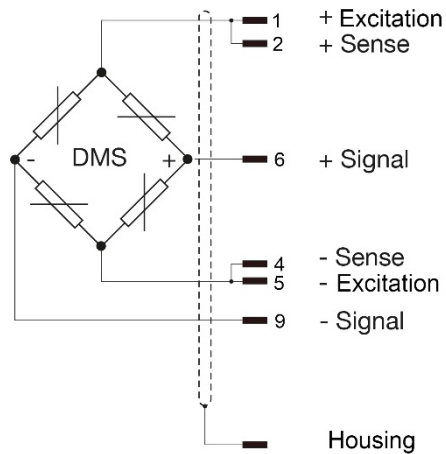

Figure 9: 9-pin connection with 6-wire system

Tension and Compression Load Cell 8524

5.3.1.2 Option 8524-xxxx-xxTxxxxx

Connection to burster devices with 9-pin D-sub socket with 6-wire system with burster TEDS.

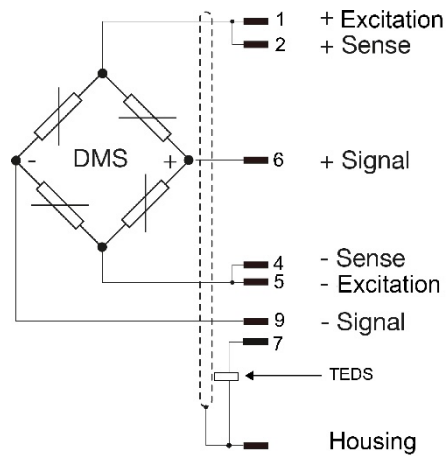
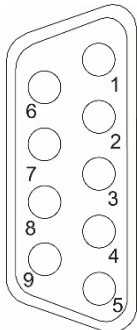

Figure 10: Device connection

Figure 11: Connection to 9-pin burster TEDS

5.3.1.3 Option 8524-xxxx-xxExxxxx

Connection to burster devices with 9-pin D-sub socket with 4-wire system for 9163-V3xxx.

IMPORTANT: Only applicable to 9163 digital indicator.

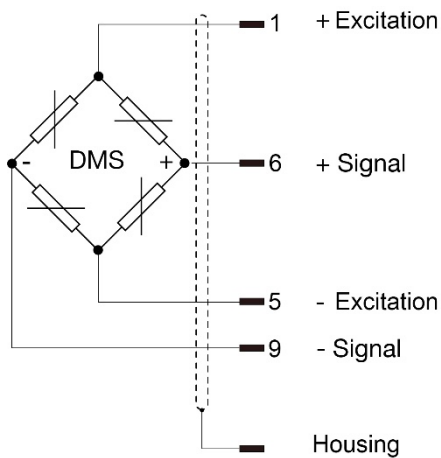
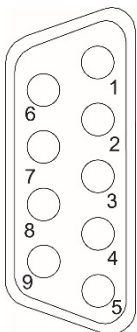

Figure 12: Device connection

Figure 13: 9-pin connection with 4-wire system

5.3.1.4 Option 8524-xxxx-xxFxxxxx

Connection to burster devices with 12-pin round connector.

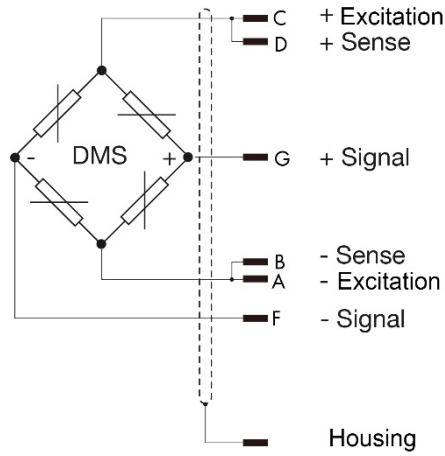
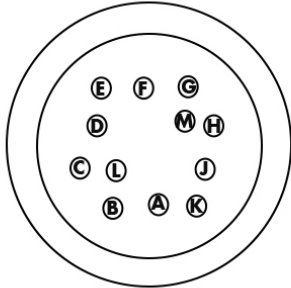

Figure 14: Device connection

Figure 15: 12-pin round connector pin assignment

5.3.1.5 Option 8524-xxxx-xxHxxxxx

Connection with 8-pin connector.

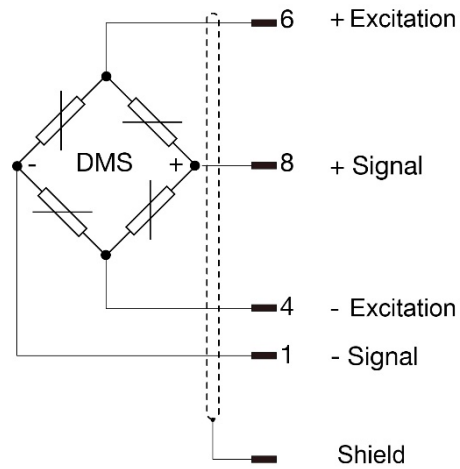
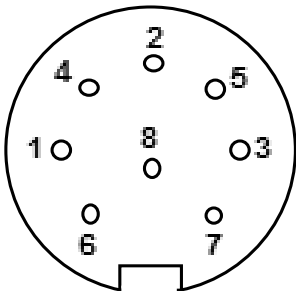

Figure 16: Solder side

Figure 17: 8-pin connector pin assignment

6 Measurement chain calibration

Each model 8524 tension and compression load cell is supplied with an individual test and calibration certificate. You can also download this test and calibration certificate at a later date by entering the serial number on the burster website (www.burster.com)

The downstream electronics must always be calibrated for the respective model 8524 tension and compression load cell. For details on calibration, see the operation instructions for the relevant downstream electronics.

7 Technical data

Please refer to the enclosed data sheet for the technical specification. The latest version of the data sheet is available at: <https://www.burster.de/en/sensors/load-cells/tension-and-compression-load-cells/p/detail/8524> or simply use the following QR code:



Figure 18: Technical data QR code

7.1 Electromagnetic compatibility

7.1.1 Interference immunity

Interference immunity in compliance with EN 61326-1:2013 and EN 61326-2-3:2006
Industrial environment

7.1.2 Interference emission

Interference emission in compliance with EN 61326-1:2013 and EN 61326-2-3:2006

8 Accessories available

Please refer to the enclosed data sheet for details of the accessories available. The latest version of the data sheet is available at: <https://www.burster.de/en/sensors/load-cells/tension-and-compression-load-cells/p/detail/8524> or simply use the following QR code:



Figure 19: Accessories available

9 Disposal



Instrument disposal

If your instrument is no longer usable, please comply with your legal obligations by disposing of the instrument described here in accordance with statutory regulations. You will then be helping to protect the environment!