

# Flange adapter 8625 & 8630, measurement ranges 20 N·m & 50 N·m

## MODEL 8600-Z002



### Highlights

- Easy to mount on the passive side of the 8625 or 8630
- Flexible assembly options through threads and holes
- Screws for mounting on the sensor included in delivery



Model 8625



Model 8630

### Product description

Applications in which a vertical torque introduction is necessary or useful can be solved with this flange adapter without great mechanical effort. Simple integration into existing systems with flange connections is also possible.

There are threads and through-holes available for fastening the flange, which ensures maximum flexibility. When installing the flange adapter, the tightening torque must be observed.

### Dimensional drawing – 8600-Z002

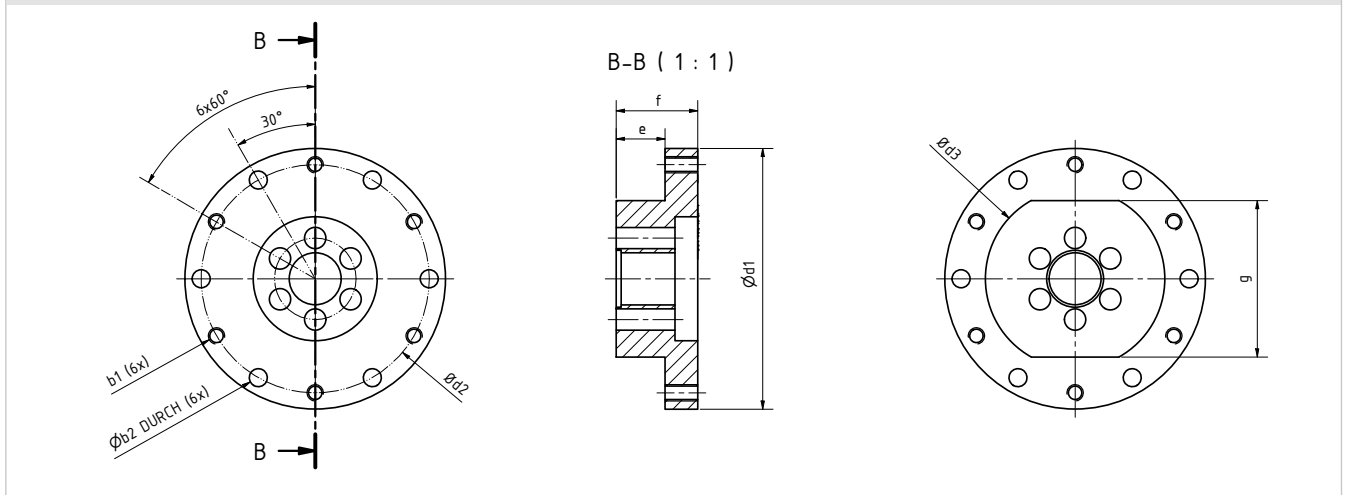

8600-Z002		b1	b2	d1	d2	d3	e	f	g
Dimensions	[mm]	M5	5.5	80	70	55	15	25	48

### Tightening torques according to ISO 4762:

8600-Z002		Mounting flange on the sensor	Mounting flange outside
Screw size		M6 x 30	M5
Min. strength class		12.9	8.8
Tightening torque	[N*m]	17	6